

CUSTOMER APPROVAL SIGNATURE:

DATE:

AFE-2557

IN THE EVENT THERE ARE DISCREPANCIES BETWEEN THE DRAWING AND THE SPECIFICATIONS, THE SPECIFICATIONS SHALL PREVAIL.

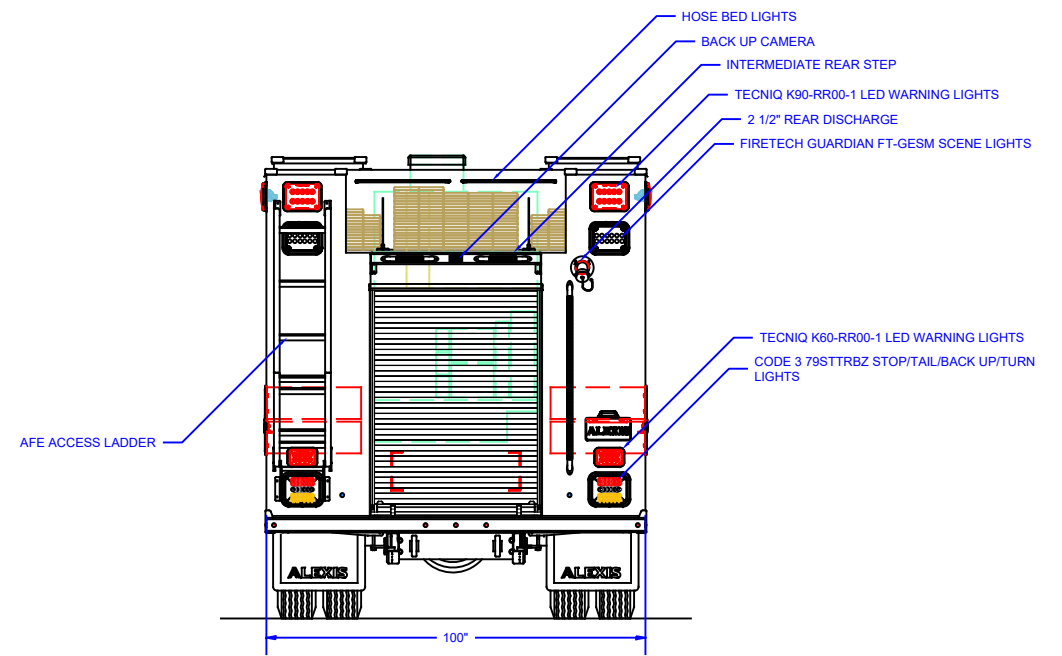
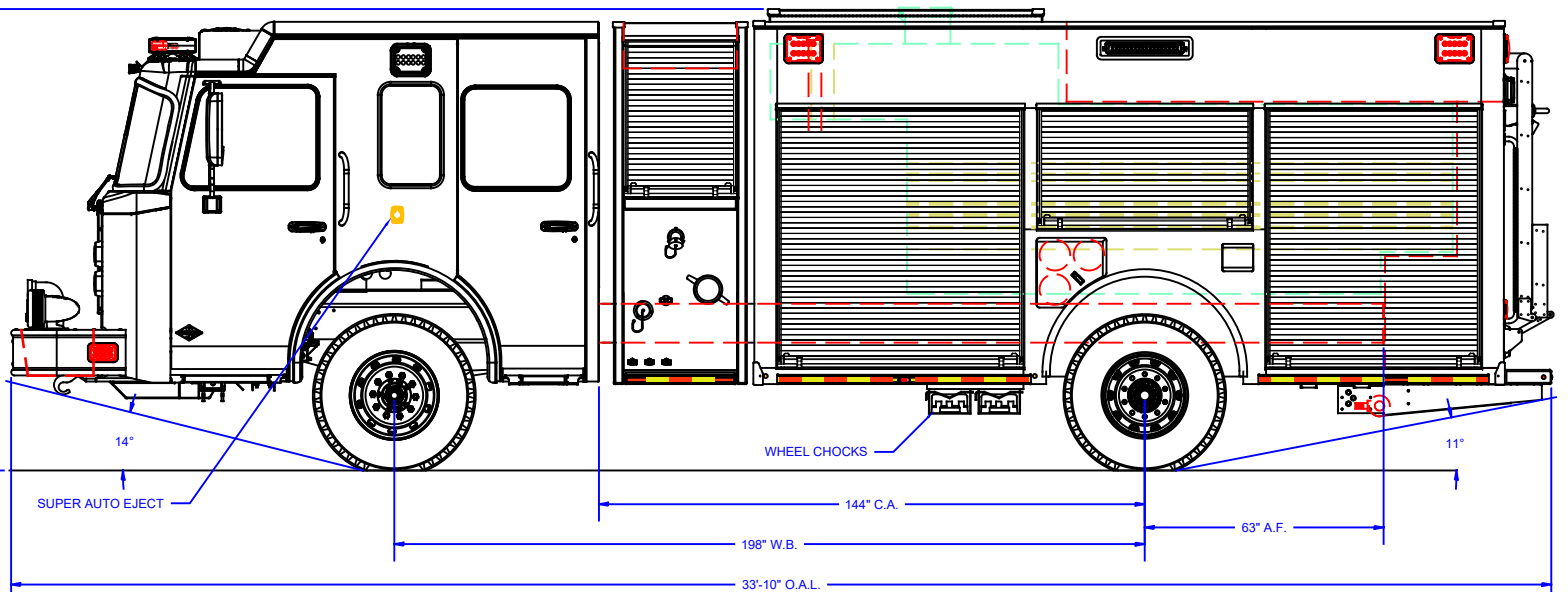
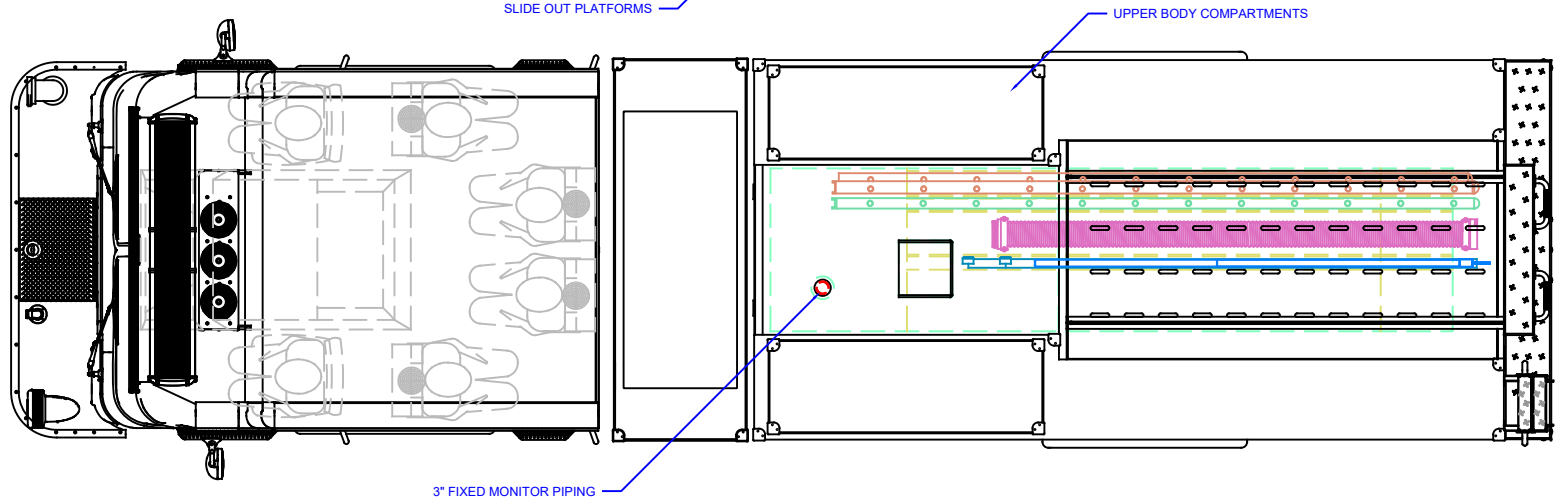
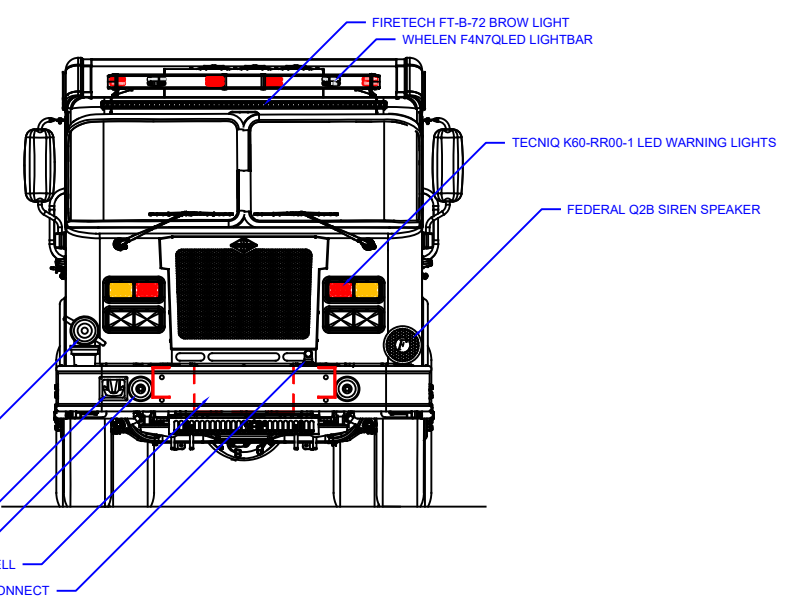
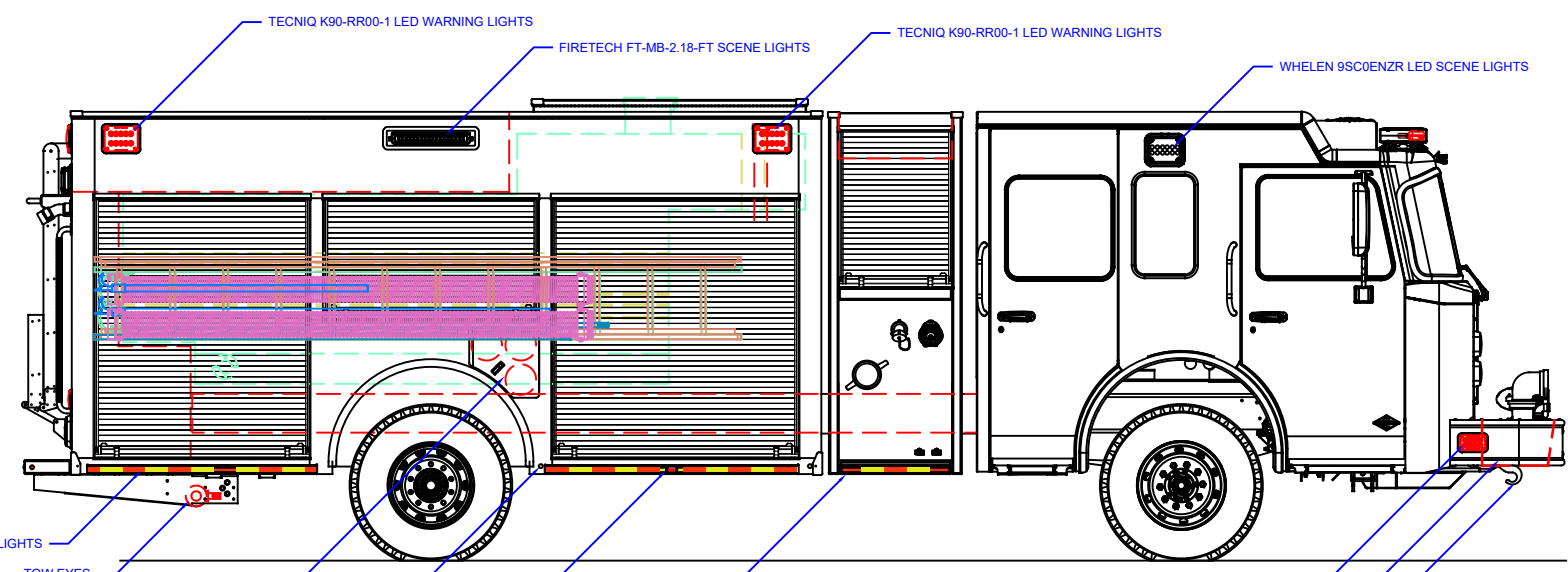

COMPARTMENT DIMENSIONS

COMP #	DOOR OPENING SIZES
L1 & R1	63" WIDE X 64" HIGH X 25" DEEP
L2 & R2	54" WIDE X 27" HIGH X 25" DEEP
L3 & R3	54" WIDE X 64" HIGH X 25" DEEP
REAR	43" WIDE X 55" HIGH X 29" DEEP

Pump Info:	
Control Location: Side	Apparatus Type: Pumper
Pump Drive: Split Shaft	Chassis: SPARTAN FC-94 MFD
Pump Make: Waterous	Tank Capacity: 1000
Pump Model: CXVC20	
Pump GPM: 1500	Material: Stainless Steel

REVISION HISTORY			
REV	DESCRIPTION	DATE	DWN

UNLESS OTHERWISE SPECIFIED DIMENSIONS ARE IN INCHES TOLERANCES ARE NOT CUMULATIVE
 DECIMAL ±0.062 ANGULAR ±0.5° FRACTIONAL ±1/16 METRIC ±1.6 mm
 The copyright of this drawing and design and the right of reproduction there is vested in and belongs to Alexis Fire Equipment Co.
 DRAWN M. TINKHAM 11/1/23
 MATERIAL

ALEXIS FIRE EQUIPMENT CO.
 P.O. BOX 549, ALEXIS, ILLINOIS 61412
RIV PUMPER
 ALEXIS FIRE EQUIPMENT
 ALEXIS, IL
 SIZE SCALE DWG NO
 D 1/2" = 1' RIV-B17-A
 CONTRACT # 2557 SHEET 1 OF 2

CUSTOMER APPROVAL SIGNATURE:

DATE:

AFE-2557

IN THE EVENT THERE ARE DISCREPANCIES BETWEEN THE DRAWING AND THE SPECIFICATIONS, THE SPECIFICATIONS SHALL PREVAIL.

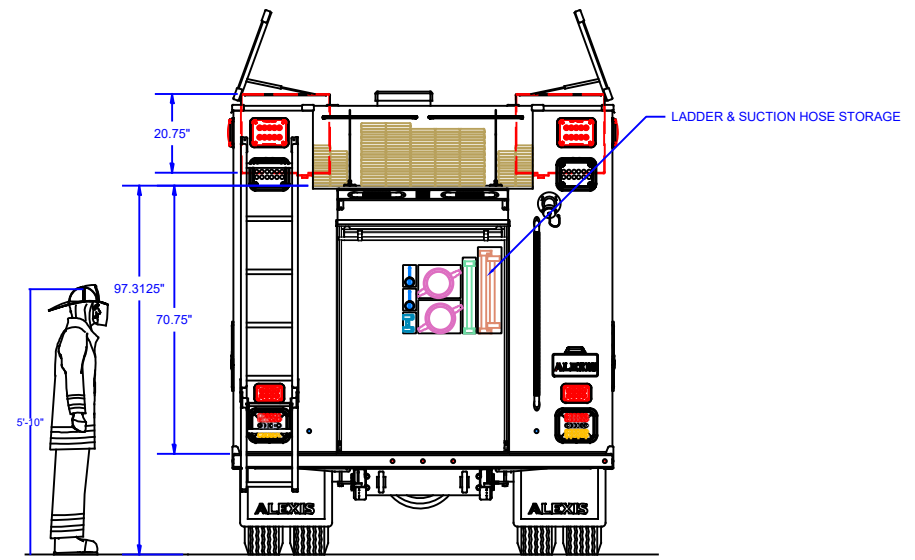
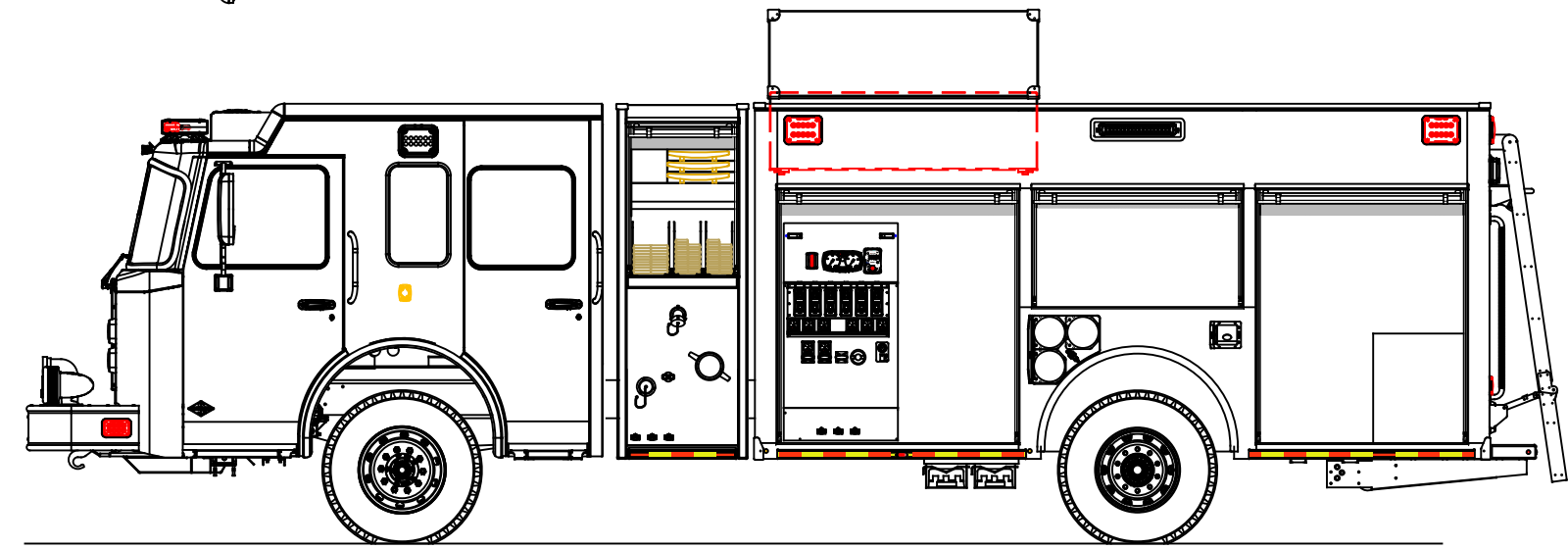
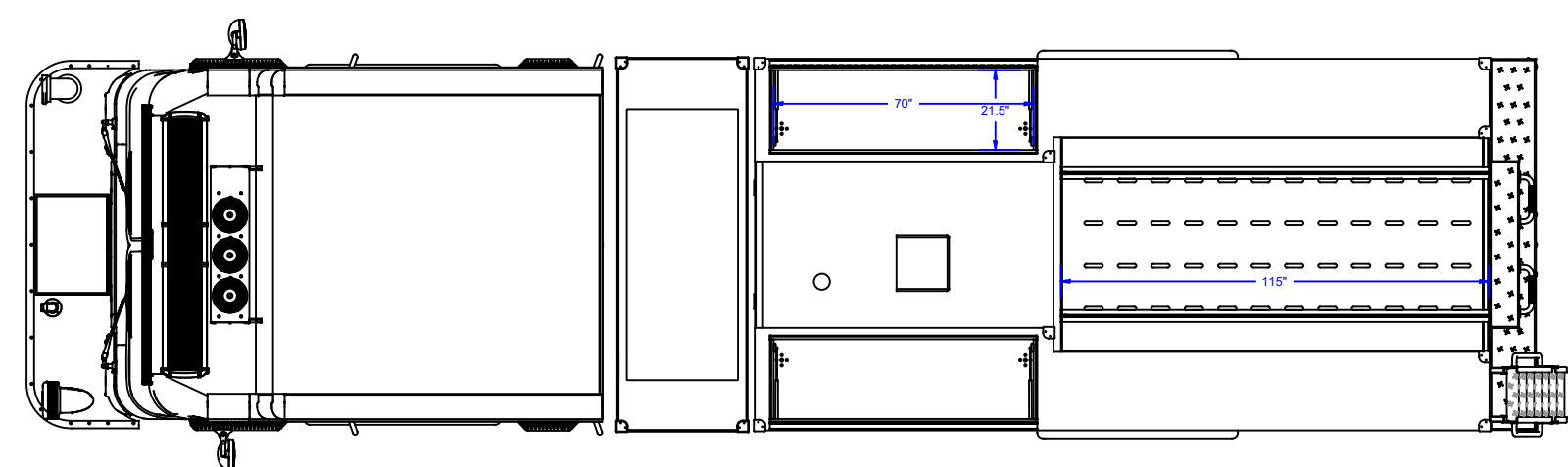
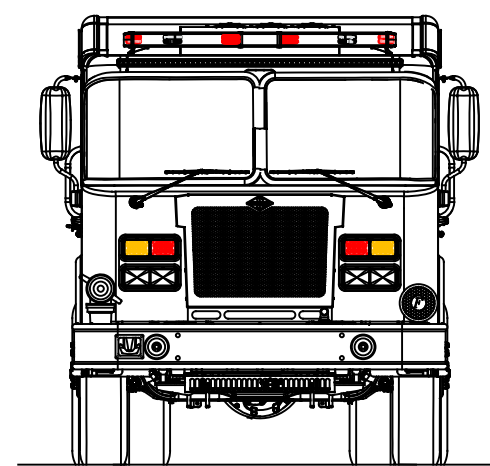
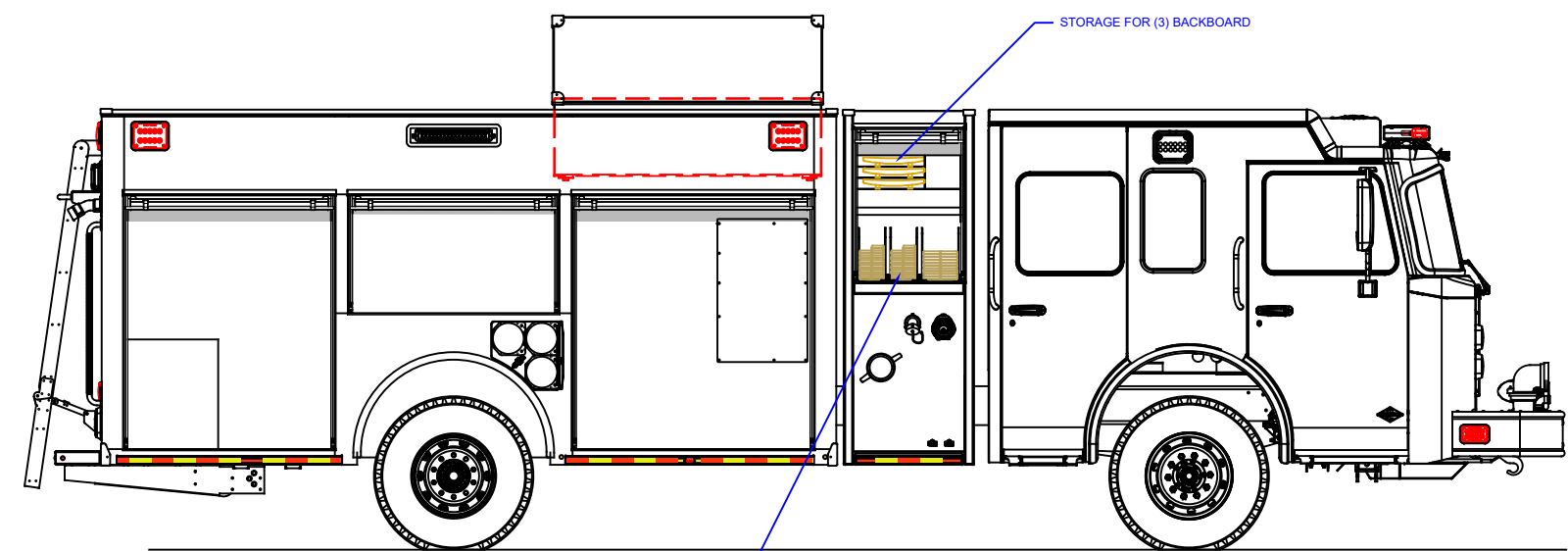

REVISION HISTORY			
REV	DESCRIPTION	DATE	DWN

Pump Info:		Apparatus Type: Pumper
Control Location: Side	Pump Drive: Split Shaft	Chassis: SPARTAN FC-94 MFD
Pump Make: Waterous	Pump Model: CXVC20	Tank Capacity: 1000
Pump RPM: 1500	Material: Stainless Steel	

COMPARTMENT DIMENSIONS	
COMP #	DOOR OPENING SIZES
L1 & R1	63" WIDE X 64" HIGH X 25" DEEP
L2 & R2	54" WIDE X 27" HIGH X 25" DEEP
L3 & R3	54" WIDE X 64" HIGH X 25" DEEP
REAR	43" WIDE X 55" HIGH X 29" DEEP

UNLESS OTHERWISE SPECIFIED
DIMENSIONS ARE IN INCHES
TOLERANCES ARE NOT CUMULATIVE

DECIMAL ±0.062 ANGULAR ±0.5°
FRACTIONAL ±1/16 METRIC ±1.6 mm

The copyright of this drawing and design
and the right of reproduction there is vested
in and belongs to Alexis Fire Equipment Co.

DRAWN: M. TINKHAM 11/1/23
MATERIAL: 2

ALEXIS FIRE EQUIPMENT CO.
P.O. BOX 549, ALEXIS, ILLINOIS 61412

RIV PUMPER
ALEXIS FIRE EQUIPMENT
ALEXIS, IL

SIZE: D 1/2" = 1'
SCALE: 1/2" = 1'
DWG NO: RIV-B17-A
CONTRACT #: 2557 SHEET 1 OF 2

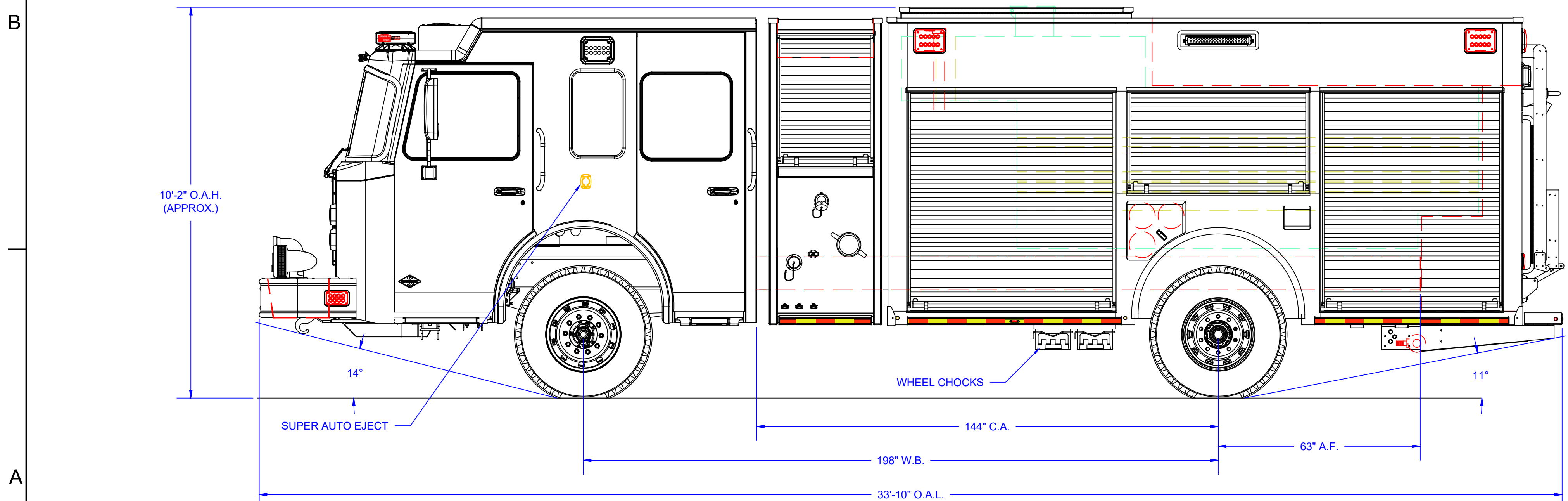
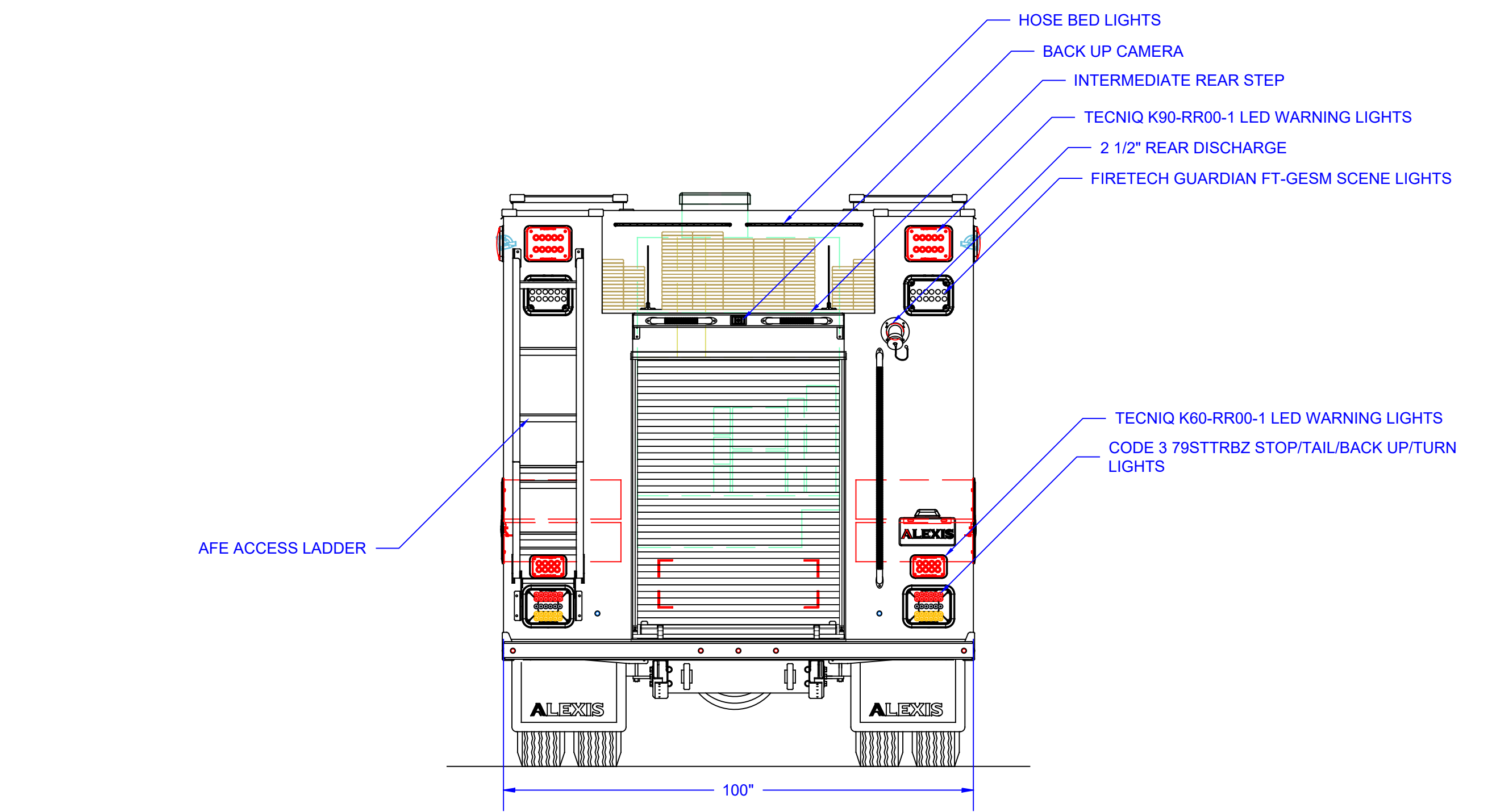
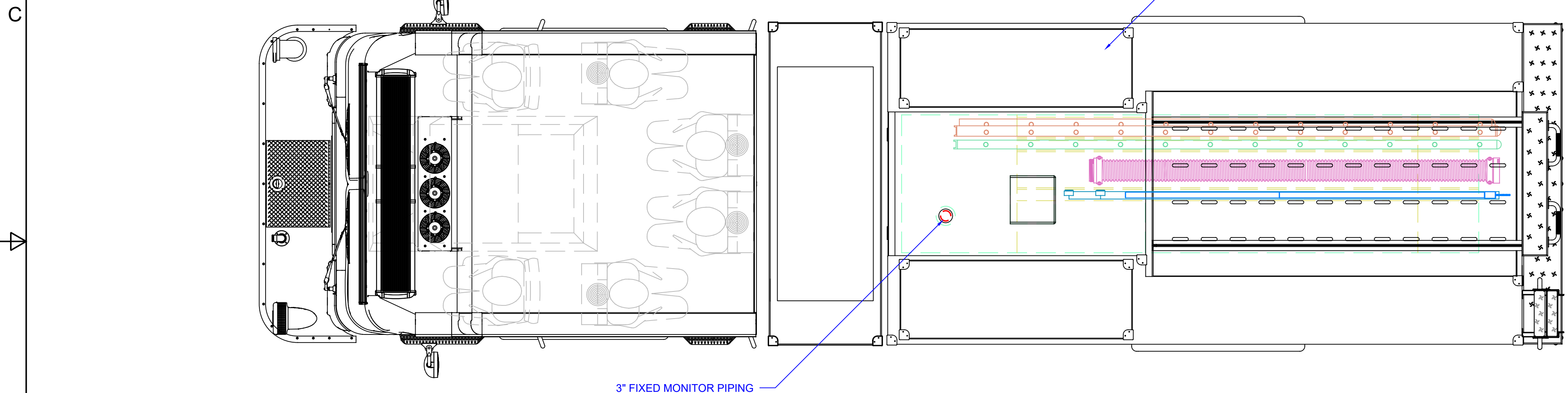
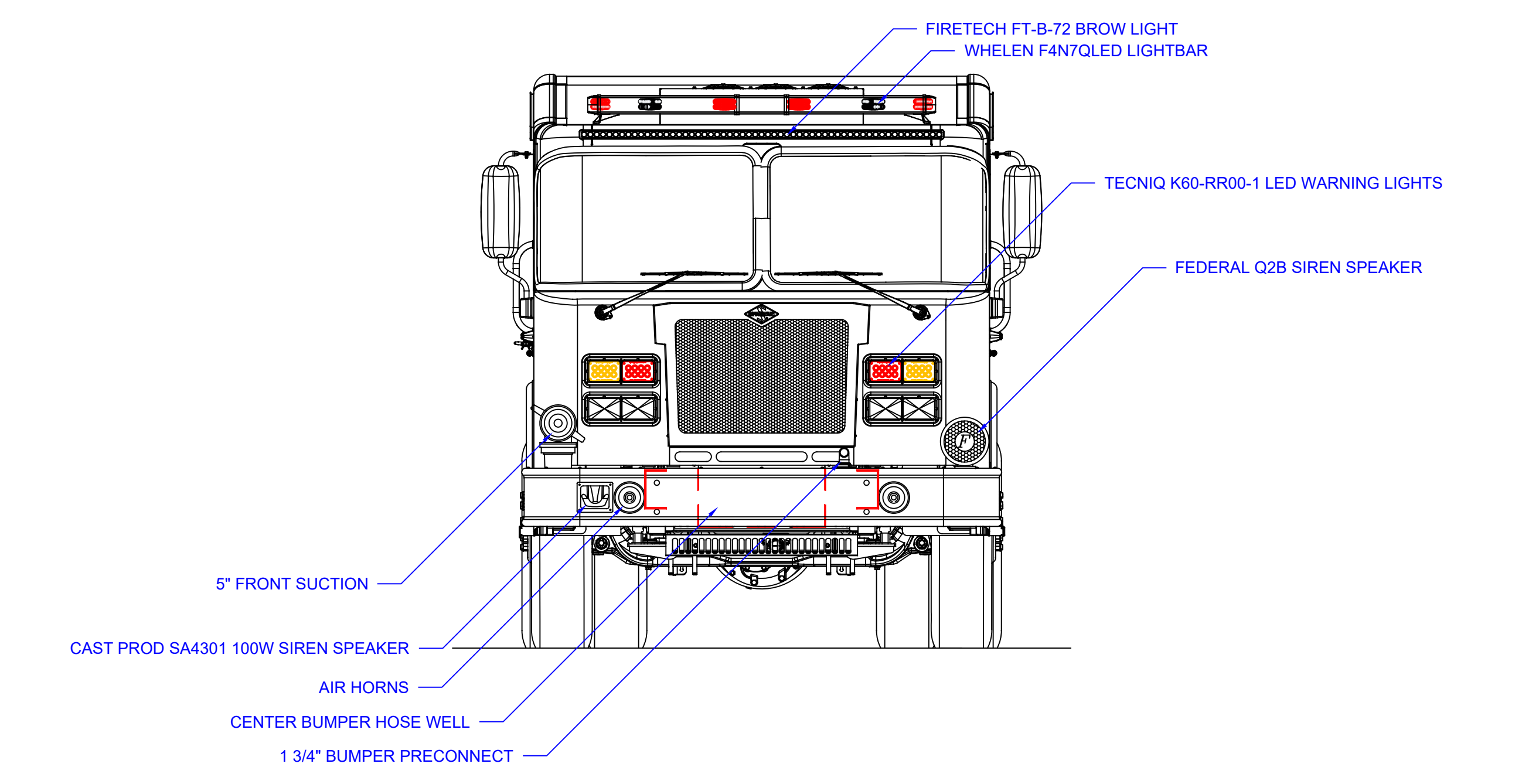
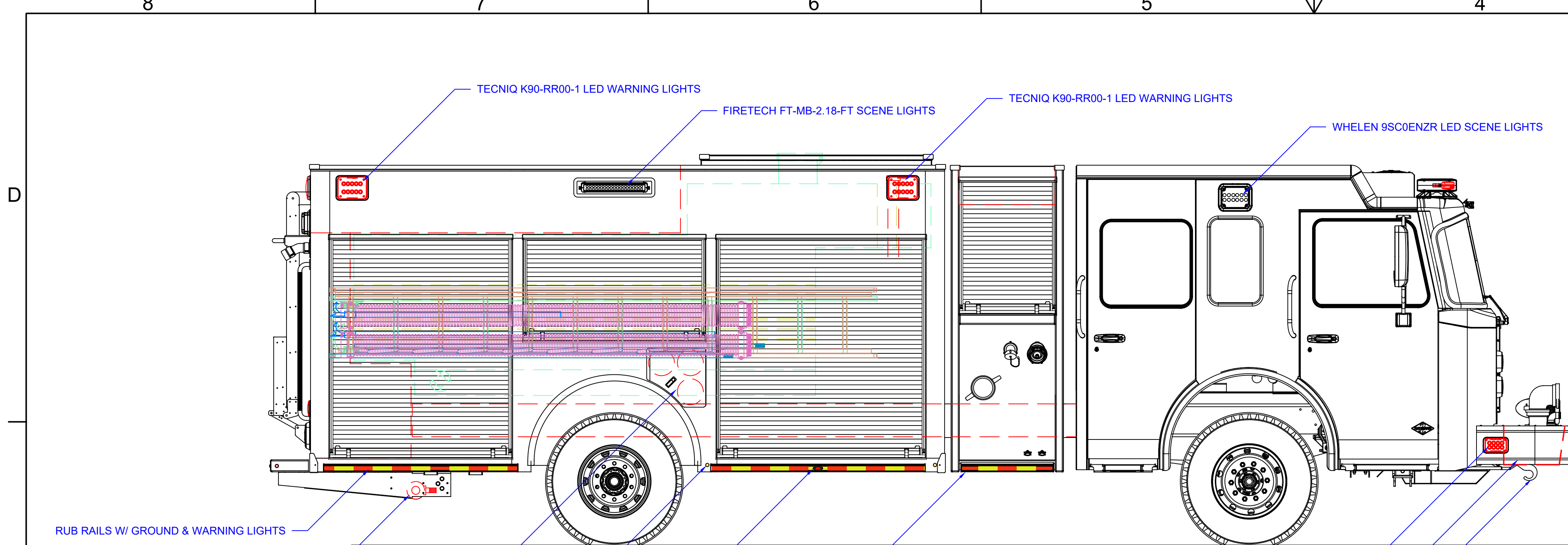

COMPARTMENT DIMENSIONS	
COMP #	DOOR OPENING SIZES
L1 & R1	63" WIDE X 64" HIGH X 25" DEEP
L2 & R2	54" WIDE X 27" HIGH X 25" DEEP
L3 & R3	54" WIDE X 64" HIGH X 25" DEEP
REAR	43" WIDE X 55" HIGH X 29" DEEP

UNLESS OTHERWISE SPECIFIED DIMENSIONS ARE IN INCHES TOLERANCES ARE NOT CUMULATIVE
 DECIMAL ± 0.062 ANGULAR ± 0.5° FRACTIONAL ± 1/16 METRIC ± 1.6 mm

ALEXIS FIRE EQUIPMENT CO.
 P.O. BOX 549, ALEXIS, ILLINOIS 61412

RIV PUMPER
 ALEXIS FIRE EQUIPMENT
 ALEXIS, IL

DRAWN: M. TINKHAM 11/1/23
 MATERIAL: _____

SIZE: D SCALE: 1/2" = 1' DWG NO: RIV-B17-A
 CONTRACT #: 2557 SHEET 1 OF 2

Pump Info:	Apparatus Type: Pumper
Control Location: Side	Chassis: SPARTAN FC-94 MFD
Pump Drive: Split Shaft	Tank Capacity: 1000
Pump Make: Waterous	Material: Stainless Steel
Pump Model: CXVC20	
Pump GPM: 1500	

REVISION HISTORY			
REV	DESCRIPTION	DATE	DWN

CUSTOMER APPROVAL SIGNATURE:

DATE:

AFE-2557

IN THE EVENT THERE ARE DISCREPANCIES BETWEEN THE DRAWING AND THE SPECIFICATIONS, THE SPECIFICATIONS SHALL PREVAIL.

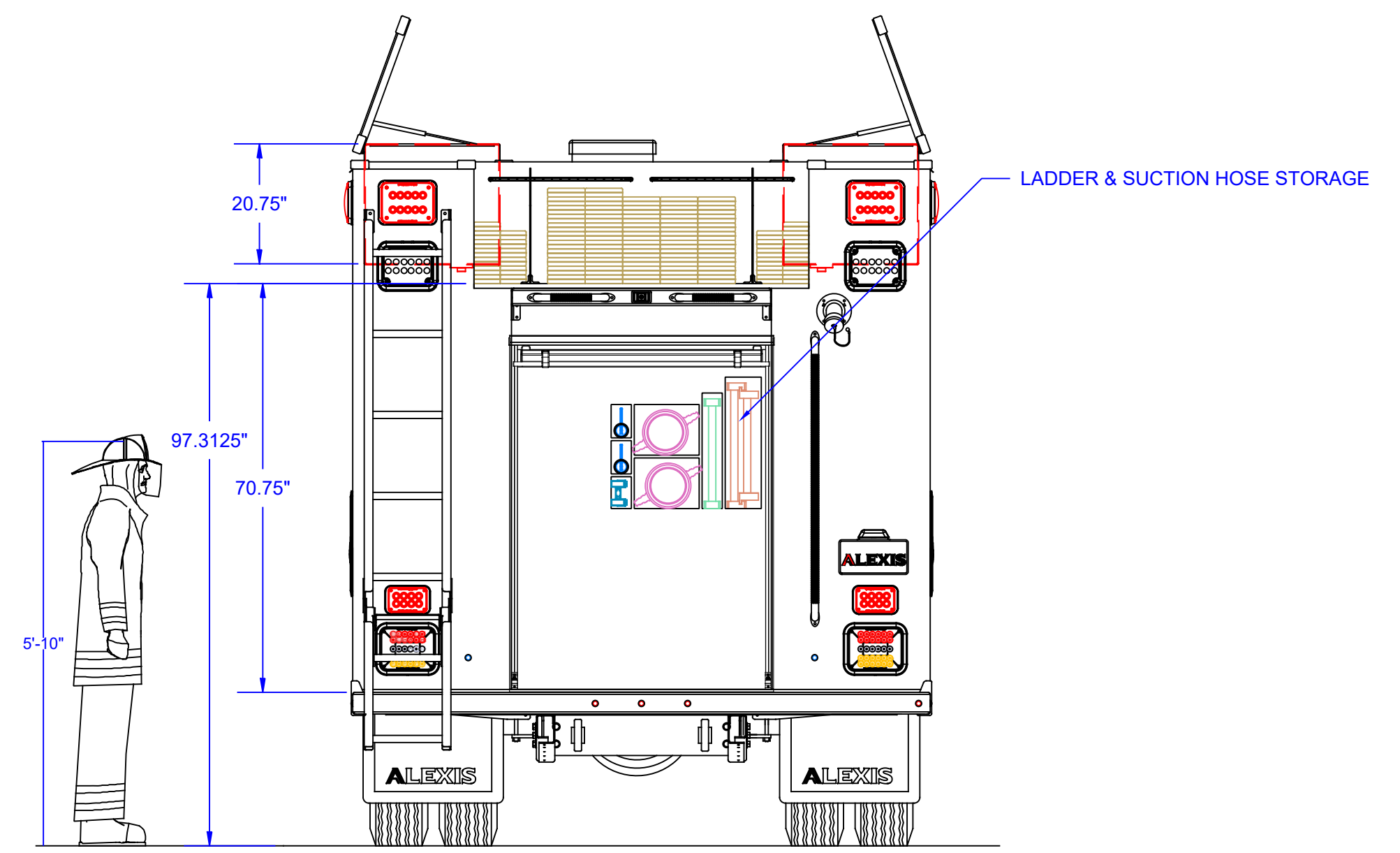
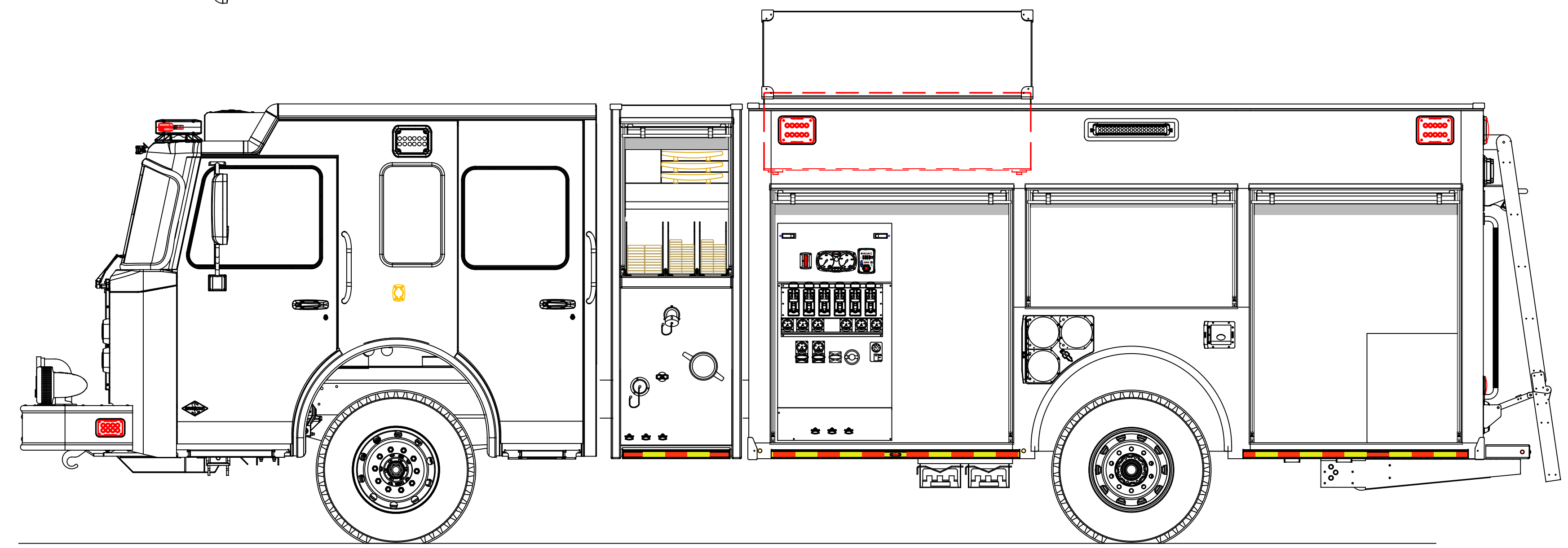
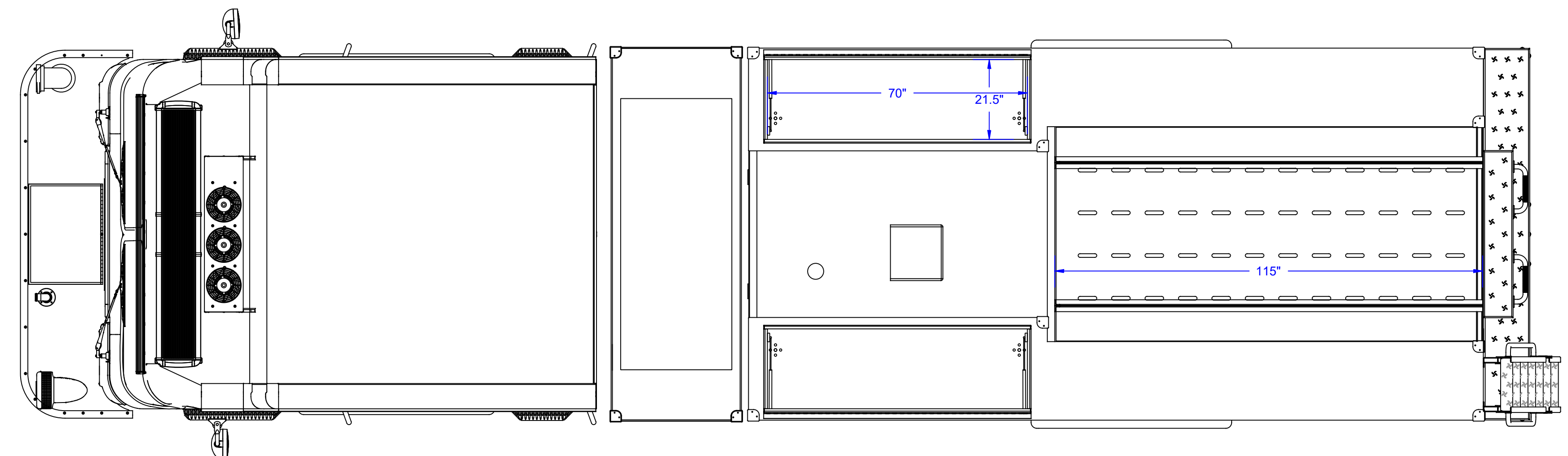
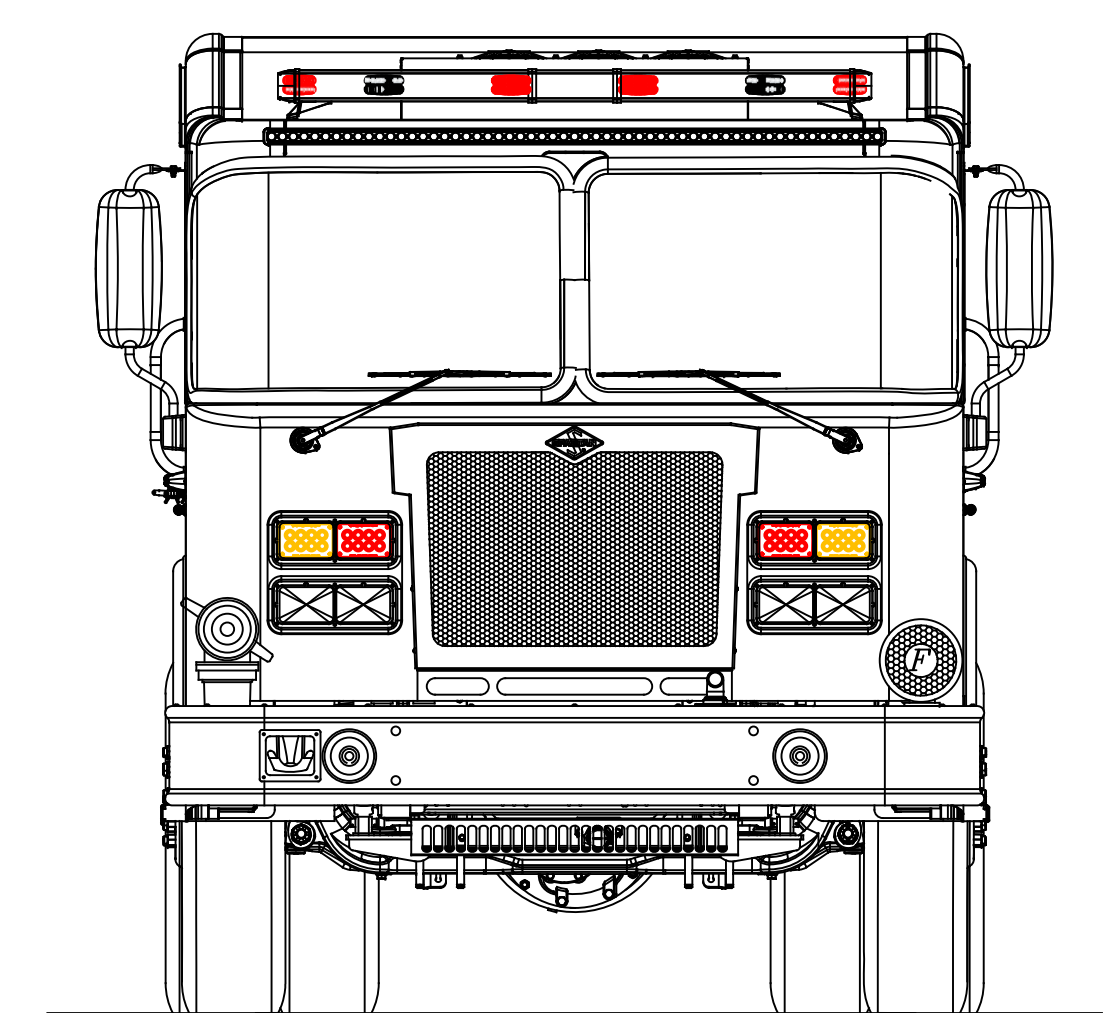
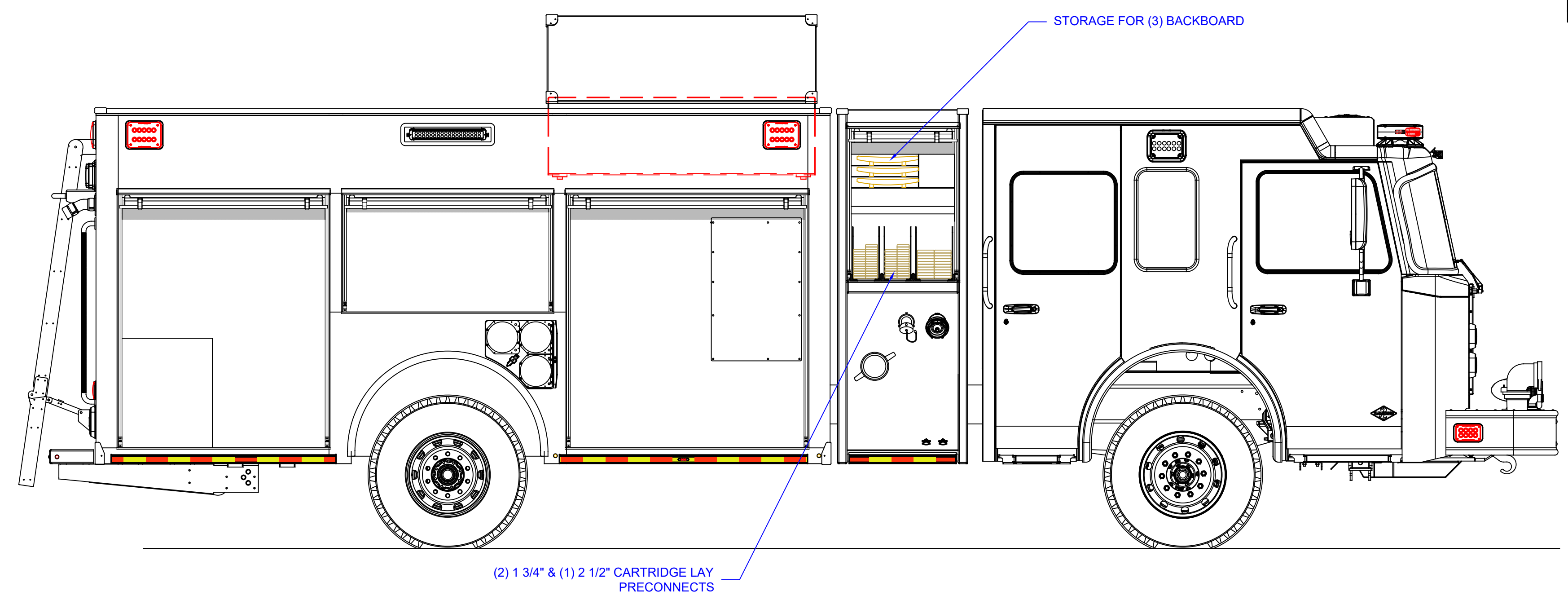

REVISION HISTORY			
REV	DESCRIPTION	DATE	DWN

Pump Info:	Apparatus Type: Pumper
Control Location: Side	Chassis: SPARTAN FC-94 MFD
Pump Drive: Split Shaft	Tank Capacity: 1000
Pump Make: Waterous	Material: Stainless Steel
Pump Model: CXVC20	
Pump GPM: 1500	

COMPARTMENT DIMENSIONS	
COMP #	DOOR OPENING SIZES
L1 & R1	63" WIDE X 64" HIGH X 25" DEEP
L2 & R2	54" WIDE X 27" HIGH X 25" DEEP
L3 & R3	54" WIDE X 64" HIGH X 25" DEEP
REAR	43" WIDE X 55" HIGH X 29" DEEP

UNLESS OTHERWISE SPECIFIED
DIMENSIONS ARE IN INCHES
TOLERANCES ARE NOT CUMULATIVE

DECIMAL ± 0.062 ANGULAR ± 0.5°
FRACTIONAL ± 1/16 METRIC ± 1.6 mm

The copyright of this drawing and design
and the right of reproduction there is vested
in and belongs to Alexis Fire Equipment Co.

DRAWN M. TINKHAM 11/1/23
MATERIAL

ALEXIS FIRE EQUIPMENT CO.
P.O. BOX 549, ALEXIS, ILLINOIS 61412

RIV PUMPER
ALEXIS FIRE EQUIPMENT
ALEXIS, IL

SIZE SCALE DWG NO
D 1/2" = 1' RIV-B17-A

CONTRACT # 2557 SHEET 1 OF 2

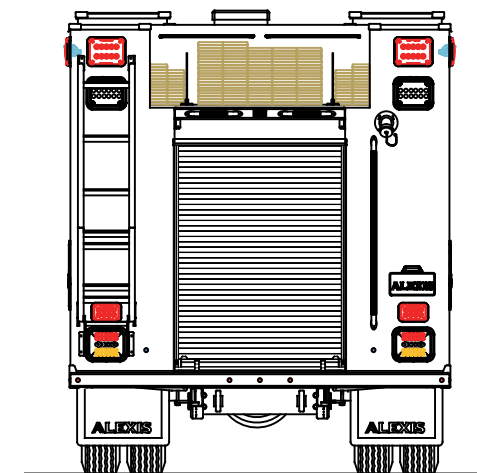
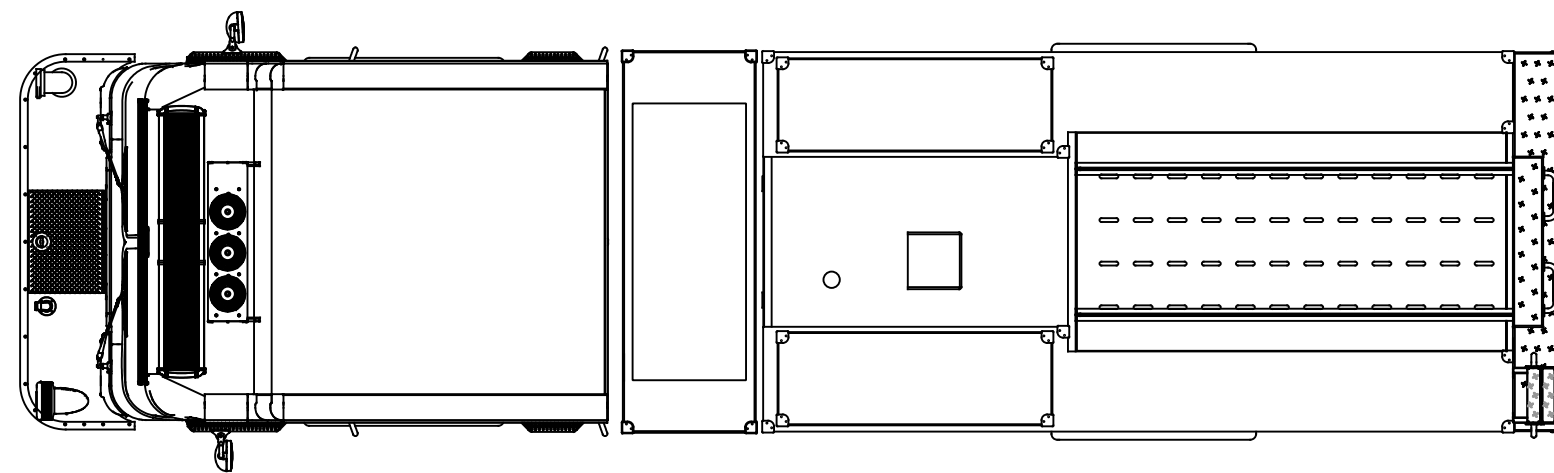
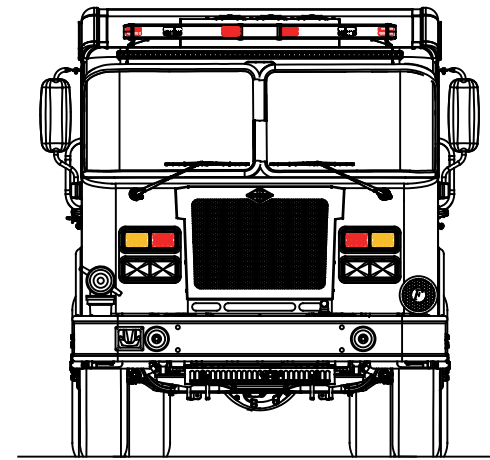
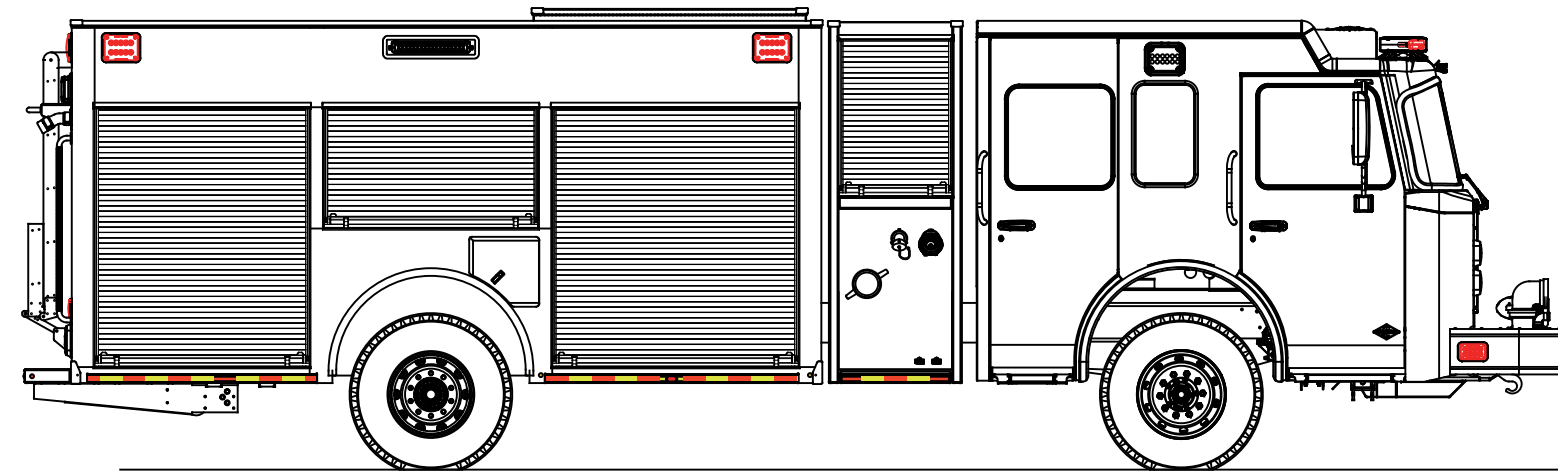

UNLESS OTHERWISE SPECIFIED DIMENSIONS ARE IN INCHES TOLERANCES ARE NOT CUMULATIVE		ALEXIS FIRE EQUIPMENT CO. P.O. BOX 549, ALEXIS, ILLINOIS 61412	
DECIMAL ±0.062	ANGULAR ±0.5°	RIV PUMPER ALEXIS FIRE EQUIPMENT ALEXIS, IL	
FRACTIONAL ±1/16	METRIC ±1.6 mm		
The copyright of this drawing and design and the right of reproduction there is vested in and belongs to Alexis Fire Equipment Co.		SIZE SCALE D 1/2" = 1'	DWG NO RIV-B17-A
DRAWN M. TINKHAM	11/1/23	CONTRACT # 2557	SHEET 1 OF 2



 Alexis Fire Equipment
 109 East Broadway / Alexis, IL 61412
 800-322-2284  sales@alexisfire.com
 AlexisFire.com

Alexis Fire Equipment Company
Alexis, IL

We hereby propose to furnish, after your acceptance, approval, and proper execution of the accompanying contract, the fire apparatus as follows:

One (1) Alexis Demo #2557 RIV Pumper

As per specifications attached herewith.

TOTAL APPARATUS.....\$ *

* Does not include any applicable taxes. Any local or state tax, if applicable, must be added to the above price.

Shipment of completed apparatus shall be made within 550 calendar days after our approval of properly signed contract, subject to causes beyond our control. This proposal is made subject to your acceptance within thirty (30) days from date of same. If acceptance is delayed beyond that period, we will, upon request, advise you of any increase in said amount which may be occasioned by causes beyond our control.

Respectfully submitted,
ALEXIS FIRE EQUIPMENT COMPANY

By: _____

"QUALITY HAS NO SUBSTITUTE"



 Alexis Fire Equipment
109 East Broadway / Alexis, IL 61412
 800-322-2284  sales@alexisfire.com
 AlexisFire.com

PAYMENT TERMS

The chassis payment shall be made within ten (10) days of invoicing.

A progress payment of \$ shall be made within ten (10) days of invoicing, upon the initial construction of the apparatus body. The ___ Fire Department may **DEDUCT \$** from the front page price for this payment.

The balance of the contract plus any contract alterations shall be payable upon the delivery of the finished unit.

Upon payment, the Alexis Fire Equipment Company shall furnish the purchaser a "Statement of Origin" or the necessary validated documents required for title application.

Additional payment terms available upon request.



 Alexis Fire Equipment
109 East Broadway / Alexis, IL 61412
 800-322-2284  sales@alexisfire.com
 AlexisFire.com

ISO 9001:

Alexis Fire Equipment Company operates a Quality Management System under the requirements of ISO 9001. These standards, sponsored by the "International Organization for Standardization (ISO)," specify the quality systems that shall be established by the manufacturer for design, manufacture, installation and service.



 Alexis Fire Equipment
109 East Broadway / Alexis, IL 61412
 800-322-2284  sales@alexisfire.com
 AlexisFire.com

SERVICE CENTER:

The Alexis Priority-One service team is staffed with factory trained mechanics ready to meet your service requirements. Our staff is continually working on maintaining updated EVT and ASE certification.

The Alexis Service Team is available 24 hours a day, 7 days a week for your service emergencies. We use the latest paging system for fast, efficient and reliable service.

Our service facility covers an area of approximately 14,000 square feet.

The Alexis Service Team can assist you in fire apparatus service, ambulance service, aerial device maintenance, generator and rescue tool maintenance and service, and air pack inspections. Our staff can provide our customers with a complete apparatus training program, meeting the latest training requirements.

Alexis is a single source warranty center for the following manufacturers: Spartan Motors, Darley, Hale, and Waterous.

Our service team has over 50 years of cumulative experience in the fire service industry. In addition, they are backed by our fabrication, electrical, and paint and finish departments. This combination of training and hands-on experience offers true reliability and dependability.

Alexis keeps detailed documentation of all repair, maintenance, and inspection performed by our personnel. With time and manpower at such a premium among many fire departments, why not allow the Alexis Service Team to set up and maintain records for your fleet?

The Alexis Service Team is committed to providing prompt and courteous service, quality products and fair pricing.

Business: Alexis Fire Equipment Company
Location: 109 East Broadway Alexis, IL 61412
Phone: 800-322-2284



 Alexis Fire Equipment
109 East Broadway / Alexis, IL 61412
 800-322-2284  sales@alexisfire.com
 AlexisFire.com

DELIVERY:

The finished apparatus shall be picked up by the dealer organization at the plant site of the Alexis Fire Equipment Company in Alexis, Illinois.

To ensure proper break-in of all drive train components while under warranty, the finished apparatus shall be delivered to the purchaser under its own power.

The apparatus shall be covered by comprehensive and liability insurance during the delivery period. The purchaser shall assume the insurance obligation on acceptance, and at that time shall present to the manufacturer's agent a certificate of verification, showing liability, comprehensive and collision insurance coverage.



GENERAL INFORMATION:

LOCATION

The Alexis Fire Equipment facilities are located at 109 East Broadway, Alexis, Illinois 61412. We maintain a complete stock of parts and services available around-the-clock. We also propose to maintain parts and service for a minimum period of twenty (20) years on all apparatus which is manufactured.

NOTATION

To further assure the customer of our ability to manufacture quality fire apparatus, we are proud of the fact that Alexis Fire Equipment Company is family-owned and has been in the fire apparatus business since 1947. All apparatus manufactured by Alexis Fire Equipment are designed and built to meet the requirements of the latest edition of NFPA 1901.

PERSONNEL CAPACITIES

To meet the spirit of N.F.P.A. 1500 paragraph 6.3.1, this apparatus has been designed to transport not more than six (6) people.

6.3 Riding in Fire Apparatus

6.3.1 All persons riding in fire apparatus shall be seated and belted securely to the vehicle by seat belts in approved riding positions and at any time the vehicle is in motion. Standing or riding on tailsteps, sidesteps, running boards or in any other exposed position shall be specifically prohibited.

MAXIMUM TOP SPEED:

To meet the intent of NFPA 1901 4.15.2, the top speed of the vehicle shall not exceed 68 MPH or the manufacturer's maximum fire service speed rating for the tires installed on the apparatus, whichever is lower.

INFORMATION TO BE PROVIDED:

Alexis Fire Equipment Company shall supply, at the time of delivery, the following documents:

A) The manufacturer's record of apparatus construction details, including the following information:

1. Owner's name and address
 2. Apparatus manufacturer, model, and serial number.
 3. Chassis make, model, and serial number.
 4. GAWR of front and rear axles.
 5. Front tire size and total rated capacity in pounds.
 6. Rear tire size and total rated capacity in pounds.
 7. Chassis weight distribution in pounds with water and manufacturer mounted equipment.
 8. Engine make, model, serial number, number of cylinders, bore, stroke, displacement and compression ratio, rated horsepower and related speed, and no-load governed speed.
 9. Type of fuel and fuel tank capacity.
 10. Electrical system voltage and alternator output in amps.
 11. Battery make and model, capacity in CCA.
 12. Transmission make, model, and type.
 13. Pump to drive through the transmission (yes or no)
 14. Engine to pump gear ratio used
 15. Pump make, model, rated capacity in g.p.m., serial number, number of stages, and impeller diameter in inches.
 16. Pump transmission make, model, and serial number.
 17. Priming device type.
 18. Type of pump pressure control system.
 19. Auxiliary pump make, model, rated capacity in g.p.m., serial number, number of stages, and impeller diameter in inches.
 20. Water tank certified capacity in gallons.
 21. Aerial device type, rated vertical height in feet, rated horizontal reach in feet, and rated capacity in pounds.
 22. Paint numbers
 23. Company name and signature of responsible company executive.
- B) If the apparatus has a fire pump, the pump manufacturer's certification of suction capability.
- C) If the apparatus has a fire pump, a copy of the apparatus manufacturer's approval for stationary pumping applications.
- D) If the apparatus has a fire pump, the engine manufacturer's certified brake horsepower curve for the engine furnished, showing the maximum no-load governed speed.
- E) If the apparatus has a fire pump, the pump manufacturer's certification of hydrostatic test.
- F) If the apparatus has a fire pump, the certification of inspection and test for the fire pump.
- G) If the apparatus has an aerial device, the certification of inspection and test for the aerial device.
- H) If the apparatus has an aerial device, all the technical information required for inspections to comply with NFPA.
- I) Weight documents from a certified scale - showing actual loading on the front axle, rear axle(s), and overall vehicle (with the water tank full but without personnel, equipment, and hose) - shall be

supplied with the completed vehicle.

- J) Written load analysis and results of the electrical system performance tests.
- K) If the apparatus is equipped with a water tank, the certification of water tank capacity.
- L) If the apparatus has a fire pump, two (2) copies of the pump operation and maintenance manual.
- M) Two (2) destination effective wiring diagrams.
- N) Copies of electrical and mechanical component manuals for equipment purchased on or with the apparatus.
- O) A sketch of the booster tank indicating all dimensions and baffle locations.
- P) If the apparatus has a pump, one (1) certification of third party test

WARRANTY:

Alexis Fire Equipment Co., Inc. warrants each new piece of Alexis fire and rescue apparatus to be free from defects in material and workmanship under normal use and service. Our obligation under this warranty is limited to repairing or replacing, as the company may elect, any part or parts thereof which shall be returned to us with transportation charges prepaid, and as to which examination shall disclose to the company's satisfaction to have been defective, provided that such part, or parts shall be returned to us not later than two years after delivery of such vehicle. Such defective part or parts will be repaired or replaced free of charge and without charge for installation to the original purchaser. All water tanks will be warranted as stated herein and may have extended warranty as explained elsewhere in the Alexis Fire Equipment Co. Proposal.

This warranty will not apply:

1. To normal maintenance service or adjustments.
2. To any vehicle which shall have been repaired or altered outside of our factory, in any way so as, in our judgement, to affect its stability, nor which has been subject to misuse, negligence, or accident, nor to any vehicle made by us which shall have been operated at a speed exceeding the factory rated speed, or loaded beyond the factory rated load capacity.
3. To the chassis and associated equipment furnished with chassis, signaling device, generators, batteries or other trade accessories. These are usually warranted separately by their respective manufacturers.
4. To work performed by an outside service without prior authorization obtained from Alexis Fire Equipment.
5. To costs incurred from an outside service for non-warranty related items.



This warranty is in lieu of all other warranties, expressed or implied, and all other representations to the original purchaser and all other obligations or liabilities, including liability for incidental or consequential damages on the part of the company. We neither assume or authorize any other person to give or assume any other warranty or liability o the company’s behalf unless made or assumed in writing by the company.

Surety Bond, if required, will cover standard two-year warranty period only and will not cover any extended warranties allowed by Alexis Fire Equipment co. or other component manufacturers.

LENGTH AND/OR HEIGHT LIMITATIONS:

OVERALL HEIGHT:

There shall be no overall height restrictions.

OVERALL LENGTH:

There shall be no overall length restrictions.

CHASSIS MODIFICATIONS:

MUD FLAPS:

Each rear fender shall be extended with a black rubber mud flap, thus preventing splash and road debris from damaging the apparatus body.

CHASSIS SUPPLIED WHEELS:

The wheel finish on the apparatus shall remain as specified in the chassis specifications.

LABELS:

A permanent plate in the driving compartment shall specify the quantity and type of the following fluids used in the vehicle:

- Engine Oil
- Engine Coolant
- Chassis Transmission Fluid
- Pump Transmission Lubrication Fluid

- Pump Primer Fluid (if applicable)
- Drive Axle(s) Lubrication Fluid
- Air-Conditioning Refrigerant
- Air-Conditioning Lubrication Oil
- Power Steering Fluid
- Cab Tilt Mechanism Fluid
- Transfer Case Fluid
- Equipment Rack Fluid
- CAFS Air Compressor System Lubricant
- Generator System Lubricant
- Front Tire Cold Pressure
- Rear Tire Cold Pressure
- Maximum Tire Speed Ratings

A final manufacturer's certification of the GVWR or GCWR along with a certification of each GAWR, shall be supplied on a label affixed to the vehicle.

A sign that reads "Occupants Must Be Seated and Belted When Apparatus Is in Motion" shall be provided. The sign shall be visible from each seated position.

A label that states the number of personnel the vehicle is designed to carry shall be located in an area visible to the driver.

A sign stating the overall height of the vehicle in feet and inches, the overall length of the vehicle in feet and inches, and the GVWR in tons shall be provided and mounted. The sign shall be visible to the driver of the vehicle while seated.

A label stating "Do Not Wear Helmet While Seated" shall be visible from each seating position.

A label stating "All Equipment Stored in the cab shall be properly secured" shall be visible from each seating position.

A "Do Not Ride" label shall be visible near all stepping and standing surfaces

FUEL TANK:

The chassis shall incorporate a rear fuel tank installed by the chassis manufacturer. The fill and vent shall be installed behind the left rear wheel in a recessed housing with a hinged stainless steel door, Model 101426. The fill shall be labeled with the type of fuel intended.

CAB TILT PENDANT CONNECTION:

The chassis supplied cab tilt connection shall be mounted on the right side of the apparatus. For a pumper, the receptacle shall be located on the discharge panel. For a rescue, the receptacle shall be located in the R1 compartment.

HOSE STORAGE DURATILE:

Black Duratile shall be installed in the bottom of the chassis supplied bumper hose storage to insure proper hose ventilation and drying.

AIR LIMITER:

A limiter valve shall be installed on the chassis air reserve tank, eliminating the use of all air accessories when the chassis air pressure is under 100 psi, thus reserving all available air for braking effort.

HELMET STORAGE:

To meet the intent of NFPA 14.1.8.4.1, the helmet for each occupant shall be stored in an exterior compartment.

PUMP AND PIPING:

WATEROUS CX-1500 SPLIT SHAFT PUMPING SYSTEM:

MANUFACTURER: Waterous
MODEL: CXVC20
CAPACITY: 1500 gpm at 150 psi

The CX 1250 shall be designed and have the capacity of 1500 GPM rated performance.

DESCRIPTION:

The efficient performance and modern design make the CX series pumps outstanding in their class. The combination of single-stage design and vertically-split volute and pump transmission provide a simple to operate, easy to maintain pump. The use of heavy-duty gears, bearings and shafts provides longer, more trouble-free service and a high reserve capacity. The pump shall utilize a Waterous C20 series chain drive transmission and shall be driven off the split shaft driveline.

The CX is equipped with Victaulic® intake and discharge fittings for rear mount applications.



PUMP SPECIFICATIONS:

CASING:

Two-Piece, vertically-split, high-tensile, close-grained gray iron

IMPELLER:

Flame Plated bronze impeller specifically designed for the fire service, double hubbed to eliminate axial thrust, and accurately balanced for vibration-free running.

WEAR RINGS:

Replaceable bronze wear rings to increase pump life and keep maintenance costs at a minimum.

IMPELLER SHAFT:

Stainless steel, heat treated, precisely ground to size, and polished under shaft seal. Supported by oil lubricated ball bearings.

BEARINGS:

All bearings are oil or grease lubricated, ball-type, located outside the pump casting to accurately align and support the impeller shaft assembly. Ball bearings are deep groove type designed to carry both radial and axial thrust.

GEARS:

Crown shaved, carburized and hardened gears are constant mesh, helical design, for quiet operation and long life.

PRIMING PUMP:

The priming pump shall be a Trident Emergency Products compressed air powered, high efficiency, multi-stage, venturi based AirPrime™ System. All wetted metallic parts of the priming system are to be of brass and stainless steel construction. A single panel mounted control will activate the priming pump and open the priming valve to the pump. The priming system shall have a five year warranty.

ADDITIONAL PRIMER CONTROL:

One (1) additional primer control valve shall be furnished to prime the specified auxiliary inlet individually. The Trident Emergency products RPV (remote priming valve) shall activate using the same air that powers the AirPrime™ system when the coinciding panel valve is depressed. Priming the remote suction line evacuates air from that line and minimizes cavitation during remote suction operations. The valve control is to be co-located next to the main priming valve control on the pump operator's panel.

AUXILARY INLET: Front Intake

DRIVELINES:

The chassis drivelines shall be modified to accept the pump drivelines. The pumping system drivelines shall be manufactured by the apparatus manufacturer. The drivelines shall be professionally balanced by the apparatus manufacturer to ensure complete system balance.

6" SUCTION:

One (1) 6" NST suction shall be located on each side of the apparatus body. The suctions shall be open and not gated. An inlet screen and a 6" handle cap shall be included.

PIPING:

The piping will be stainless steel material throughout the waterway system. The suction waterway shall be 6" 304 stainless steel material. The suction waterways shall be designed to flow a minimum of 17% in excess of the rated capacity from draft. The suction piping shall incorporate a 4" suction inlet to allow for full flow from the tank valve assembly. The suction piping shall be adapted from 6" TIPT to NST with a chrome adapter. The suction system shall be designed with 6" victaulic couplings to allow ease of access for maintenance or removal of the pumping system.

The discharge system shall incorporate a 4" stainless steel distribution system. The manifold shall be fed from the 4" piping system. The discharge system shall incorporate a 4" victaulic system to allow ease of access for maintenance or removal of the pumping system. Each discharge shall be fed from above the manifold system.

PUMP DRAINS:

The entire pump and its controls shall be drainable with a master drain piped to the lowest points of the pump and its control piping. The master drain shall be of a threaded design that will seal all drain points without allowing recycle.

WATEROUS MECHANICAL SEAL:

The mechanical seal must be 2" in diameter and shall be spring loaded, maintenance free and self-adjusting. Mechanical seal construction shall be a carbon sealing ring, stainless steel coil spring, Viton rubber cup, and a tungsten carbide seat with Teflon backup seal.

AIR PUMP SHIFT:

The shifting mechanism shall be a heat-treated, hard anodized aluminum power cylinder, with stainless steel shaft. The assembly shall be plumbed utilizing a 3/8" air line for maximum performance. An in-cab control for rapid shift shall be provided that locks in road or pump.

For automatic transmissions, three green warning lights shall be provided to indicate to the operator(s) when the pump has completed the shift from Road to Pump position. Two green lights to be located in the truck driving compartment and one green light on pump operators panel adjacent to the throttle control. For manual transmissions, one green warning light will be provided for the driving compartment. All lights shall have appropriate identification/instruction plates.

INTAKE PRESSURE RELIEF VALVE

One (1) Task Force Tips model #A1860 pressure relief valve shall be provided. The valve shall have an easy to read adjustment range from 90 to 300 PSI with easy to read 90, 125, 150, 200, 250, 300 psi settings and an "OFF" position. Pressure adjustment can be made utilizing a 1/4" hex key, 9/16" socket or 14mm socket. For corrosion resistance the cast aluminum valve shall be hardcoat anodized with a powder coat interior and exterior finish. The valve shall be configured for either a Waterous or Hale pump, and have a 2-1/2" male NH threaded discharge outlet and a "DO NOT CAP" label near discharge outlet. The valve shall meet NFPA 1901 requirements for pump inlet relief valve. The unit shall be covered by a five-year warranty.

REQUIRED PUMP TESTING:

If the fire pump has a rated capacity of 750 gpm or greater capacity, the pump shall be tested after the pump and all its associated piping and equipment have been installed on the apparatus. The tests shall be conducted at the Alexis facility and certified by an EVT Certified pump operator. The certification shall include (at least) the following tests: the pumping test, the pumping engine overload test, the pressure control system test, the priming device tests, and the vacuum test. If the apparatus is equipped with a water tank, the water tank to pump flow test shall be included.

A test plate shall be provided at the pump operator's position that gives the following information: the

rated discharges and pressures, the speed of the engine determined by the certification test for each unit, the position of the parallel/series pump as used, and the no-load governed speed of the engine stated by the engine manufacturer on a certified brake horsepower curve. The plate shall be completely stamped with all information at the factory and attached to the vehicle prior to shipping.

PUMP CERTIFICATION:

Upon final apparatus delivery, the original copy of the certificate of inspection by an independent third party shall be furnished.

The pumping system shall be capable of delivering:

- 100 % of rated capacity at 150 psi. net pump pressure
- 70 % of rated capacity at 200 psi. net pump pressure
- 50 % of rated capacity at 250 psi. net pump pressure

RIV PUMP MODULE

A 71" wide free standing pump module shall be located between the chassis cab and the front of the body. The pump module shall incorporate the pump, suction and discharge panels.

The pump module shall be a self-supported structure mounted to the frame separate from the cab and body. Pump module design begins with a cage framework assemblies that are precision manufactured from corrosion free heavy 7 gauge stainless steel forms. This framework mounts to the truck frame through a mounting design complemented with four (4) VIBRA mount elastomer cushions. The result shall be a mounting system that allows for the twisting movement of the truck frame without undue stress loading of the pump module.

The front and rear corner posts on each side of the module shall be full height.

The suction and discharge panels located on the left and right sides of the apparatus shall be removable for pump, valve, and piping access.

An automotive rubber seal shall be adhered to the pump panel to reduce vibration that may occur during pump operation or road application.

Each panel shall be secured with latches at the top and bottom of the door opening.

PUMP OPERATOR'S PANEL:

The pump operator's panel shall be located in the forward section of the L1 compartment. The top of the

operator's panel shall be hinged for access to the individual gauges and the electrical components. The bottom panel shall be removable for maintenance access. No exceptions.

There shall be a removable panel located in the R1 compartment for maintenance access.

The pump operator's panel shall include the following:

PRESSURE GOVERNOR and MONITORING DISPLAY

One (1) Fire Research PumpBoss series PBA401-D00 pressure governor and monitoring display kit shall be installed. The kit shall include a control module, intake pressure sensor, discharge pressure sensor, and cables. The control module case shall be waterproof and have dimensions not to exceed 6 3/4" high by 4 5/8". The control knob shall be 2" in diameter with no mechanical stops, have a serrated grip, and a red idle push button in the center. It shall not extend more than 1 3/4" from the front of the control module. Inputs for monitored engine information and outputs for engine control shall be on the J1939 databus. Inputs from the pump discharge and intake pressure sensors shall be electrical.

The following continuous displays shall be provided:

- Engine RPM; shown with four daylight bright LED digits more than 1/2" high
- Check engine and stop engine warning LEDs
- Engine oil pressure; shown on a dual color (green/red) LED bar graph display
- Engine coolant temperature; shown on a dual color (green/red) LED bar graph display
- Transmission Temperature; shown on a dual color (green/red) LED bar graph display
- Battery voltage; shown on a dual color (green/red) LED bar graph display
- Pressure and RPM operating mode LEDs
- Pressure / RPM setting; shown on a dot matrix message display
- Throttle ready LED.

The dot-matrix message display shall show diagnostic and warning messages as they occur. It shall show monitored apparatus information, stored data, and program options when selected by the operator. All LED intensity shall be automatically adjusted for day and night time operation.

The program shall store the accumulated operating hours for the pump and engine to be displayed with the push of a button. It shall monitor inputs and support audible and visual warning alarms for the following conditions:

- High Battery Voltage
- Low Battery Voltage (Engine Off)
- Low Battery Voltage (Engine Running)
- High Transmission Temperature
- Low Engine Oil Pressure
- High Engine Coolant Temperature
- Out of Water (visual alarm only)

No Engine Response (visual alarm only).

The program features shall be accessed via push buttons located on the front of the control module. There shall be a USB port located at the rear of the control module to upload future firmware enhancements.

The governor shall operate in two control modes, pressure and RPM. No discharge pressure or engine RPM variation shall occur when switching between modes. A throttle ready LED shall light when the interlock signal is recognized. The governor shall start in pressure mode and set the engine RPM to idle. In pressure mode the governor shall automatically regulate the discharge pressure at the level set by the operator. In RPM mode the governor shall maintain the engine RPM at the level set by the operator except in the event of a discharge pressure increase. The governor shall limit a discharge pressure increase in RPM mode to a maximum of 30 psi. Other safety features shall include recognition of no water conditions with an automatic programmed response and a push button to return the engine to idle.

The pressure governor and display shall be programmed to interface with a Cummins engine.

MASTER GAUGES:

One (1) 4½" compound gauge with a range of 30-0-400 PSI.

One (1) 4½" pressure gauge with a range of 0-400 PSI

WATER TANK INDICATOR

One (1) Fire Research TankVision Pro model WLA300-A00 tank indicator kit shall be installed. The kit shall include an electronic indicator module, a pressure sensor, and a 10' sensor cable. The indicator shall show the volume of water in the tank on nine (9) easy to see super bright RGB LEDs. A wide view lens over the LEDs shall provide for a viewing angle of 180 degrees. The indicator case shall be waterproof, manufactured of Polycarbonate/Nylon material, and have a distinctive blue label.

The program features shall be accessed from the front of the indicator module. The program shall support self-diagnostics capabilities, self-calibration, six (6) programmable colored light patterns to display tank volume, adjustable brightness control levels and a datalink to connect remote indicators. Low water warnings shall include flashing LEDs at 1/4 tank, down chasing LEDs when the tank is almost empty, and an output for an audio alarm.

The indicator shall receive an input signal from an electronic pressure sensor. The sensor shall be mounted from the outside of the water tank near the bottom. No probe shall be placed on the interior of the tank. Wiring shall be weather resistant and have automotive type plug-in connectors.



The gauge shall be located at the pump operator’s panel.

LINE READING GAUGES:

One (1) line reading gauge supplied for each discharge. The gauge shall have a 2½ diameter face with a graduated output scale of 0-400 PSI with black print on a bright white background. The gauge shall be constructed with a Zytel housing, acrylic lens and polished stainless steel bezel. The Zytel nylon case shall be temperature compensated with an internal breathing diaphragm to permit a fully filled case and to allow for a rigid lens with a distortion free viewing area.

A 1/4" brass male NPT fitting shall be centrally located on the rear of the housing and feature the Kem-X socket and freeze protection system that isolates the gauge from contaminants. The gauge utilizes a phosphor bronze Bourdon tube filled with a freeze proof liquid isolated by a diaphragm. The gauge shall be filled with low temperature glycerin for an operating range of -40 to +150 degrees Fahrenheit, which prevents bouncing of the readout needle and provides for an accuracy rating of plus or minus 1% across the entire scale of the gauge.

COLOR CODED TAGS:

Color coded tags with chrome plated bezels shall be provided. Unless otherwise specified all tags shall be color coded to NFPA recommendations and shall be located at the control location, intake/discharge location, and at the drain port location.

Alexis Standard Tags:

Front Bumper Jump Line	Orange
Preconnect #1	Red
Preconnect #2	Yellow
Preconnect #3	Seafoam
Discharge #1	White
Discharge #2	Blue
Discharge #3	Black
Discharge #4	Green
Discharge #5/Water tower	Purple
Deluge/deck gun	Silver
Booster line (1 1/2" or hose)	Red with white border

TEST PORTS:

Vacuum and pressure test ports shall be provided on the pump operator's panel for connection of the pump test gauges.

PUSH BUTTON ON PUMP PANEL FOR AIR HORNS:

There shall be a push button provided on the pump panel to activate the air horns.

RUNNING BOARDS

There shall be one (1) running board located on each side of the pump module. Each running board shall extend out to aid in accessing the upper transverse storage area. The running boards shall be constructed of 12 gauge star punched stainless steel material. The material meets NFPA standard 13-7.3: all exterior surfaces have a minimum slip resistance of .68.

RUB RAILS - RUNNING BOARDS:

Bolt on aluminum rub rails shall be installed one (1) each side on the running boards. Said rub rails will be fabricated of a polished "C" channel aluminum, mounted to the running board utilizing ¼" plastic spacers.

The rub rails shall incorporate the LED ground lights. Each light strip shall run the full length of each rub rail.

The channel designed rub rail shall incorporate a highly reflective red and fluorescent yellow green reflective stripe to aid in apparatus protection.

STAINLESS STEEL PUMP MODULE:

The area above the side discharge panels on each side shall be manufactured of 14 gauge brushed stainless steel material.

STAINLESS STEEL PUMP PANELS:

The pump operator's panel and discharge panel on the left side shall be manufactured of 12-gauge stainless steel and shall include a full width light hood with one (1) E45 Series LED light strip

The side discharge panel on the right side of the apparatus shall be manufactured of 12-gauge stainless steel and shall include a full width light hood with one (1) E45 Series LED light strip

PUMP MODULE TOP:

DUNNAGE COMPARTMENT:

One (1) pump module width dunnage compartment shall be located over the pump. The compartment shall be the same depth as the preconnect hose bed and shall incorporate deck gun piping if applicable. The dunnage compartment shall be left open, allowing full accessibility to stored equipment.

2 ½" DISCHARGE PIPING:

One (1) 2 ½" discharge(s) shall be located on the left side of the apparatus. Each discharge valve shall be located behind the body panel and controlled from the side control pump operator's panel. Each discharge shall include a self-locking 2½" quarter-turn ball valve, a 2½" chrome cap with chain, and a sweep elbow of at least 30 degrees downward.

Each above valve shall be manually controlled.

2 ½" DISCHARGE PIPING:

One (1) 2 ½" discharge(s) shall be located on the right side of the apparatus. Each discharge valve shall be located behind the body panel and shall be controlled from the side control pump operator's panel. Each shall include a self-locking 2½" quarter-turn ball valve, a 2½" chrome cap with chain, and a sweep elbow of at least 30 degrees downward.

Each above valve shall be manually controlled.

2 ½" DISCHARGE, APPARATUS REAR:

One (1) 2½" discharge shall be located on the rear of the apparatus. Each discharge shall be controlled from the side control pump operator's panel. Each shall include a self-locking 2½" quarter-turn ball valve, a 2½" chrome cap with chain, and a sweep elbow of at least 30 degrees downward.

Each above valve shall be manually controlled.

LOCATION: _____

3" DISCHARGE(S), APPARATUS RIGHT SIDE:

One (1) 3" discharge(s) shall be located on the right side of the apparatus with each valve behind the body panel. Each discharge shall be controlled from the side control pump operator's panel. A 2½" gauge shall be adjacent to each control. Each valve shall measure 3" and include an Akron Slo-Cloz adapter.

DISCHARGE ADAPTER:

The 3" discharge shall incorporate one (1) 3" NST LHF x 5" Storz 30 degree elbow with blind cap.

Each above valve shall be manually controlled.

TANK TO PUMP LINE:

One (1) 4" tank to pump line shall be installed into the tank to the suction side of the pump. It shall have 4" piping and valved with a 4" full flow valve. Each valve shall be electrically controlled from the pump operator's panel. Each tank line shall incorporate a check valve in the line to meet NFPA 1901.

LINE DRAINS FOR DISCHARGES:

The drain valves shall be Innovative Controls ¾" ball brass drain valves with chrome-plated lift lever handles and ergonomic grips. Each lift handle grip shall feature built-in color-coding labels and a verbiage tag identifying each valve, also supplied by Innovative Controls. The color labels shall also include valve open and close verbiage.

VENTED DISCHARGE CAPS:

Each discharge shall incorporate a vented cap designed to relieve stored pressure in the line when disconnected.

GATED SUCTION, LEFT SIDE:

One (1) 2½" gated suction shall be located on the left side of the apparatus. It shall be piped 2½" i.d. including a 2½" Akron full flow quarter turn valve and a 2½" NST female swivel with plug and chain. It shall be remote controlled from the suction location.

Each above valve shall be manually controlled.

FRONT SUCTION – CUSTOM CHASSIS:

One (1) 5" suction shall be located at the front of the apparatus. The suction piping shall be as described in the custom chassis specifications. An inlet screen and a long handle cap shall be included. The operator has an Open/Closed indicator device showing the valve position at all times. The butterfly valve shall be made of lightweight aluminum alloy with a bronze valve disc and 1-piece rubber seat. It shall be rated at 250 psi working pressure. The electric actuator shall have a worm gear drive system with emergency manual override. All the controls shall be within a single mountable panel package that

utilizes current limiting for fully open and closed stopping. There shall be no switches in the gear actuator housing.

INTAKE RELIEF VALVE:

One (1) TFT A1860 intake relief valve shall be installed on the auxiliary intake of the pump. The minimum range shall permit control from 75 to 250 psi. (per NFPA 4-5.1).

FRONT SUCTION ELBOW - PAINTED:

The front suction shall incorporate a 5" Elkhart 348 swivel elbow terminating as described below. The Elkhart swivel shall be painted job color.

The auxiliary suction shall terminate 6" NSTM.

FIXED MONITOR PIPING:

One (1) 3" discharge shall be located on the deck over the pump compartment. The discharge shall be flanged to adapt to a permanent mounted deck pipe. The piping shall be reinforced to allow rated deck pipe flow without piping distortion. The discharge valve shall be a quarter turn 3" full flow valve located in the pump compartment. It shall be controlled from the pump panel. The deluge and its control shall be positioned so the pump operator shall have complete control. The valve shall be a slow close valve per NFPA requirements.

Each above valve shall be manually controlled.

CARTRIDGE LAY PRECONNECT MODULE - (2) 1½" AND (1) 2½":

One (1) preconnect module shall be located above the lower pump module. The module shall be manufactured of stainless steel material, self supported, and shall incorporate two (2) preconnect hose beds above the pump.

Two (2) 1½" cartridge lay preconnects shall be incorporated at the front of the apparatus body. Each preconnect shall include a 1½" 180° swivel adapted to 1½" fire hose thread. The waterways shall measure 2" i.d. and include a 2" full flow quarter turn ball valve that is controlled from the operator's panel.

One (1) 2½" cartridge lay preconnect shall be incorporated at the front of the apparatus body. The preconnect shall include a 2½" swivel adapted to 2½" NST. The waterway shall measure 2½" i.d. and include a 2½" full flow quarter turn ball valve that is controlled from the operator's panel.

The 1½" preconnect shall have the capacity to contain not less than 200' of 1¾" double jacket hose and the 2½" preconnect shall have the capacity to contain not less than 150' of 2½" double jacket hose.

Each above valve shall be manually controlled.

Aluminum trays shall be incorporated with the system. Each tray shall be constructed of .1875" 5052 - aluminum sheet that is fabricated to accommodate the intended usage. Each cartridge shall be securely retained in the apparatus when in place.

TRANSVERSE STORAGE AREA:

There shall be a transverse storage area located above the preconnects. The storage area shall be full apparatus body width for increased storage capacity.

SLIDE OUT PLATFORMS:

Two (2) slide out platforms shall be provided one (1) each side under the pump for access to the transverse storage area. Each slide out platform shall be constructed of 12 gauge 304 star punch stainless steel material. Each platform shall utilize Accuride Zinc slides and have a capacity of 500 lb. of distributed load. Each platform shall be capable of 100% extension and shall have a lift bar latching system across the full width at the front of the platform to secure the platform in the stowed and extended position.

BACKBOARD RACK:

The transverse storage area shall incorporate one (1) backboard rack. The rack shall be manufactured of 3/16" (.1875") 5052-H32 smooth aluminum. The rack shall have the capacity to store three (3) backboards.

PRECONNECT MODULE ROLL-UP DOORS:

The preconnect module shall incorporate one (1) ROM Series IV Roll-up Shutter Door one each side finished as described below. The doors shall be made of an anodized aluminum slat incorporating an exclusive seal that prohibits water intrusion, absorbs shock, eliminates clatter, and provides quiet, vibration-free performance. The lift bar shall be a D-shaped bar for strength and ease of use. The doors shall satisfy the NFPA hose retention requirements.

TALL BOTTOM RAIL:

Each ROM door shall incorporate a tall bottom rail for improved accessibility.

PULL STRAP:

Each ROM door shall incorporate a pull strap to assist in closing the door.

PAINTED ROLL-UP DOOR:

The compartment shall have Robinson Roll-up Shutter Doors with a **paint**ed finish.

There shall be a stainless steel door guard located at the top of the compartment to protect the painted surface of the ROM door from damage while the door is open. The door opening height as stated will be reduced by approximately 2" to accommodate the door guard.

The roll-up door side tracks and top drip rail shall remain **sat**in finish.

1½" PRECONNECT, BUMPER EXTENSION:

One (1) 1½" preconnect shall be incorporated within the bumper extension. The piping shall measure 2" i.d. and shall be valved with 2" full flow quarter turn ball valves that are controlled from the operator's panel. It shall include a bumper deck mounted 1½" swivel adapted to 1½" fire hose thread

Each above valve shall be manually controlled.

TANK FILL RECYCLE:

One (1) 2" waterway shall be incorporated from the pressure side of the pump to the tank. The line shall be controlled from the pump panel and valved with a 2" ball valve to allow a pump cooling recycle or tank fill when pumping from draft. When fully opened, it shall have the capacity to refill the tank at 750 gpm when pumping at 100 psi.

VALVING:

Each and every apparatus valve must be an Akron Stainless Steel Ball Valve, per the following specifications.

An Akron Brass Generation II Swing-Out™ Valve, shall be provided. The valve shall have an all brass body with flow optimizing stainless steel ball and dual polymer seats. The valve body shall be of

universal design and accept multiple actuators. The valve shall be capable of dual directional flow while incorporating a self-locking ball feature using an automatic friction lock design and specially designed flow optimizing stainless steel ball. The stainless steel ball shall have HydroMax™ technology. All stainless steel parts must be 316 grade for increased resistance to corrosion. The valve shall not require lubrication of seats or any other internal waterway parts, and must be capable of swinging out of the waterway for maintenance by the removal of six bolts. The valve shall be compatible with a slow closing device. This valve shall be actuated using a manual handle. The handle shall be quickly adjustable to one of eight handle positions and require only 90° travel. The valve shall be manufactured and assembled in the United States. Product must carry a 10 year manufacturer's warranty.

WARRANTY, AKRON BRASS BALL VALVE:

We warrant Akron Brass Swing-Out Valves for a period of ten (10) years after purchase against defects in material or workmanship. Akron Brass will repair or replace any Swing-Out Valve which fails to satisfy this warranty. Repair or replacement shall be at the discretion of Akron Brass. Electrical Components shall carry our standard five (5) year warranty. We will not be responsible for: Wear and tear; and by improper installation use, maintenance; negligence of the owner or user; repair or modification after delivery; failure to follow our instructions or recommendations; or anything else beyond our control. WE MAKE NO WARRANTIES EXPRESS OR IMPLIED, OTHER THAN THOSE INCLUDED IN THIS WARRANTY STATEMENT, AND WE DISCLAIM ANY IMPLIED WARRANTY OF MERCHANTABILITY OR FITNESS FOR ANY PARTICULAR PURPOSE. Further we will not be responsible for any consequential, incidental, or indirect damages (including, but not limited to, any loss of profits) from any cause whatsoever. No person has authority to change this warranty.

PIPING:

All waterways described herein shall be of schedule 40 threaded stainless steel pipe, schedule 10 welded stainless steel, or "aeroquip" hose. Each shall be installed with the proper couplings to allow apparatus twisting, flexing, and complete removal for service or replacement.

PLUMBING WARRANTY:

The stainless steel plumbing components and ancillary brass fittings used in the construction of the water/foam plumbing system shall be warranted for a period of ten (10) years or 100,000 miles. This covers structural failures caused by defective design or workmanship, or perforation caused by corrosion, provided the apparatus is used in a normal and reasonable manner. This warranty is extended only to the original purchaser for a period of ten (10) years or 100,000 miles from the date of delivery.

PIPING CERTIFICATION:



Upon final apparatus delivery, a certification sheet shall accompany the unit stating that all piping and the pump have been hydrostatically tested to 250 psi.

BODY:

BODY WARRANTY:

Alexis Fire Equipment Company hereby extends its standard two-year fire and rescue apparatus warranty to include defects in materials and workmanship of the body as well as structural defects which, in the sole opinion of the company, substantially affect the total integrity of the body. This warranty is extended only to the original user-purchaser.

Alexis Fire Equipment warrants the 12 gauge stainless steel bodies, fabricated by Alexis Fire Equipment, under normal use and with reasonable maintenance, shall remain structurally sound for the lifetime of the apparatus per NFPA recommendations or 100,000 miles as long as the design of the apparatus complies with Alexis engineering practices.

The Company reserves the right to require any such repairs to be made either at Alexis Fire Equipment Company, Inc. or another approved service facility, at the option of Alexis Fire Equipment. Transportation cost to and from the servicing location is the responsibility of the user-purchaser.

The warranty shall be null and void if, upon inspection by the Company, the alleged defect is determined to have been caused by abuse, modification, accident, neglect, or lack of proper maintenance.

This warranty does not apply to the following items that are covered by a separate warranty: paint finish, hardware, door assemblies, moldings, and other accessories attached to the body. In addition, this warranty does not apply to any part or accessory manufactured by others and attached to the body.

Alexis Fire Equipment will be given a reasonable opportunity to investigate all claims. The purchaser must commence any action arising out of, based upon or relating to agreement or the breach hereof, within twelve (12) months from the date the cause of the action occurred.

Alexis Fire Equipment makes no other warranty, expressed or implied, with respect to the apparatus body and all implied warranties of merchantability and fitness for a particular purpose are hereby disclaimed.

BODY SUB FRAME – STAINLESS STEEL:

The body sub frame system shall be designed for the emergency service application. The sub frame shall be independent of the chassis frame and is to be constructed of heavy structural material to provide the maximum strength and body support necessary for units utilized in emergency service. The system not only is used for total support designed to carry the total load of the apparatus; the system also allows the unit to be a complete lift off transferable apparatus once completed.

The system is designed to carry the emergency apparatus on the chassis main frame in a European style method. This method allows the apparatus body to float independently from the chassis frame ahead of the rear wheels and shall be rigidly attached behind the rear axle area.

The sub frame system shall be isolated from the chassis frame with a custom full length rubber extrusion that totally locks onto each chassis frame rail. This system isolates the body from the frame while also acting as a cushion between the two units.

The sub frame system shall be manufactured completely of 304L stainless steel material. The stainless steel sub frame shall incorporate 6 x 3 x .375 304L stainless steel angle which shall run the full length of each chassis frame rail from the back of the cab to the end of the frame. The angle provides heavy duty stability to each outrigger installed on the unit. The system is designed to keep the outriggers from deflecting once the unit is loaded.

Each outrigger shall consist of a 4 x 2 x 7 gauge 304L stainless steel rectangular tubing vertical downrigger to continue the total sub frame support. Each horizontal under compartment outrigger shall be manufactured of a custom 7 gauge 304L stainless material which is formed in a channel design for maximum support. The horizontal outriggers shall include a minimum of two (2) custom designed **VibraCenters** installed on each outrigger to support the load of the body. This system also supports the compartment load and allows it to absorb the road energy and prevent premature wear of the customer's equipment which is loaded in the apparatus. Each **VibraCenter** is designed to carry the load of the apparatus per NFPA guidelines and to absorb shock loads in excess of 10 g's.

The tank cradle shall be incorporated within the sub frame system to allow for a lower vertical center of gravity and to allow the water load weight to be supported by the sub frame system. The tank cradle shall incorporate the heavy sub frame and 7 gauge 304L stainless steel channel placed in accordance with the poly tank manufacturer's recommendations. Each channel is reflex coated to prevent the water tank from chaffing with the stainless steel sub frame.

The stainless steel subframe shall be manufactured utilizing 3/8" Magna-Grip LockBolt fasteners. The fasteners are widely known as the most reliable wide grip fastening system available and also provide vibration and loosening resistance.

APPARATUS FRONT PANEL:



The vertical surfaces at the front of body shall be manufactured of 14 gauge 304 stainless steel material.

STAINLESS STEEL SIDE BODY PANELS:

The apparatus side body panels shall be full height and independent of the tank's sides. The body panels shall be constructed of 14 gauge #4 304 stainless steel material.

APPARATUS REAR PANELS:

The vertical surfaces at the rear, from the tailstep walkway to the hose bed, shall be manufactured of smooth stainless steel, in preparation for Chevron striping.

FLAT BACK TRUCK DESIGN:

The apparatus shall be of a flat back design so as to allow for ease of access to the hosebed.

WHEEL HOUSING, PAINTED SMOOTH STAINLESS STEEL:

The rear wheel housing shall be constructed of painted stainless steel and shall incorporate a polished stainless steel fenderette. The circular interliner shall be manufactured of 3/16" Tivar 1000 polymer material.

The polymer material is a chemical and corrosion resistant material, thereby preventing excess wear and corrosion from occurring due to wintertime road chemicals. The polymer material shall be held in place by the use of polymer retainers or bolts for ease of repair and access to the wheel well area.

HOSE MAT:

The hose mat shall be constructed of 5052 aluminum and shall be of a slatted design to provide proper drainage of hose bed.

TAIL STEP:

The tail step shall be constructed of 12 gauge star punched stainless steel material. The material meets NFPA standard 13-7.3: all exterior surfaces have a minimum slip resistance of .68.

REAR TOW EYES:

Two (2) 3/4" thick steel tow eyes shall be provided, one (1) on each side below the body at the rear. Each

tow eye shall be manufactured of the same material as the body subframe

TRIPLE BOTTLE AIR BOTTLE COMPARTMENT(S):

Two (2) Model 101411-1X air bottle storage compartment(s) shall be located in the apparatus wheel well assemblies. For ease of access, each bottle shall be stored within an individual storage tube manufactured of poly material. The compartment shall incorporate a vertically hinged stainless steel door with a black push button latch. Each compartment shall have the capacity to carry three (3) air bottles.

LOCATION: One (1) Each Side Ahead of the Rear Wheels

HOSE BED:

The hose bed shall be located over the booster tank, and must be accessible from the tail step and from its open top. The hose bed compartment shall have a minimum capacity of 55 cu. ft. and a minimum width of 45".

HOSE BED CAPACITY:

The hose bed shall have the capacity to carry the following hose from left to right:

Five (5) 50' sections of 2½" Double Jacket Hose

Ten (10) 100' sections of 5" LDH Hose

Five (5) 50' sections of 2½" Double Jacket Hose

HOSE BED DIVIDERS:

Two (2) dividers shall be located in the hose bed. They shall be constructed of 3/16" aluminum plate. The dividers shall be designed for future adjustability with locking blocks in aluminum channels at the front and the rear of the hose bed.

Each hose bed divider shall incorporate hand hold cutouts to assist in accessing the hose bed.

HOSE BED COVER:

One (1) custom tailored hypalon hose bed cover shall be included with the apparatus body. It shall be manufactured of a flame retardant material with a grab tensile of 480 x 500 lbs. and a tongue tear of 160

x 150 lbs. It shall be crack resistant to -40° Fahrenheit and have an adhesion lbs./in of 10.0 lbs. The hose bed cover shall be fitted to the hose bed and retained with a double woven shock cord on the front and both sides. The shock cord shall system shall utilize nylon hooks spaced every 10"-12". The cover shall be sand weighted across the rear flap and shall also include two (2) 2" wide nylon straps with teflon buckle to meet NFPA requirements.

The hose bed cover shall include a 3 year warranty.

The hypalon cover shall be black in color.

COMPARTMENTATION:

COMPARTMENT DESIGN:

The compartmentation shall be fabricated of bolted 14 gauge 304 stainless steel walls and 12 gauge 304 stainless steel floors. The compartmentation is designed to be an intricate part of the body and subframe for maximum compartment support. The compartment tops shall be fabricated of smooth stainless steel material and shall meet the intent of the latest edition of NFPA 15.7 regarding stepping, standing, and walking surfaces. The material shall be formed over each compartment top to act as drip protection over each compartment opening. The compartment flooring will be sweep out design. The front and rear corners of the body shall remain natural finish #4 stainless steel. The material be full height and shall wrap around each corner to the compartment door frame.

The specified lighting in each compartment shall be switched automatically with the doors. The lighting shall meet the requirements of NFPA 13.10.5

PAINTED ROLL-UP DOORS:

The side compartments shall have ROM Series IV Roll-up Shutter Doors with a **paint**ed finish. The doors shall be made of an anodized aluminum slat incorporating an exclusive seal that prohibits water intrusion, absorbs shock, eliminates clatter, and provides quiet, vibration-free performance. The lift bar shall be a D-shaped bar for strength and ease of use.

The rear compartment (if applicable) shall have ROM Series IV Roll-up Shutter Door with a **sat**in finish. The door shall be made of an anodized aluminum slat incorporating an exclusive seal that prohibits water intrusion, absorbs shock, eliminates clatter, and provides quiet, vibration-free performance. The lift bar shall be a D-shaped bar for strength and ease of use.

ROLL UP DOOR GUARD:

Each roll-up door shall incorporate a stainless steel guard. The guard shall be located at the top of the compartment around the roll-up door header to protect the finish of the roll-up door when the door is in the up position. The door opening height as stated will be reduced by approximately 2" to accommodate the door guard.

TALL BOTTOM RAIL:

Each ROM door shall incorporate a tall bottom rail for improved accessibility.

The roll-up door side tracks and top drip rail shall remain **sat**in finish.

LEFT SIDE BODY SHALL BE AS FOLLOWS:

L1

A roll-up door compartment assembly with a door opening of 63" wide x 64" high x 25" deep shall be incorporated on the apparatus left side ahead of the rear wheels.

The compartment shall include the following:

Unistrut Tracking

E45 Series LED strip lights to illuminate the entire area. The lights shall run the entire height of the compartment on each side of the door opening.

L2

One (1) compartment with a roll-up door shall be located above the wheel well on the left side. It shall have a door opening of 54" wide x 27" high x 25" deep.

The compartment shall include the following:

Unistrut Tracking

E45 Series LED strip lights to illuminate the entire area. The lights shall run the entire height of the compartment on each side of the door opening.

L3

A roll-up door compartment assembly with a door opening of 54" wide x 64" high x 25" deep shall be

incorporated on the apparatus left side behind the rear wheels.

The L3 compartment shall extend to the rear body panel.

The compartment shall include the following:

Unistrut Tracking

E45 Series LED strip lights to illuminate the entire area. The lights shall run the entire height of the compartment on each side of the door opening.

RIGHT SIDE BODY SHALL BE AS FOLLOWS:

R1

A roll-up door compartment assembly with a door opening of 63" wide x 64" high x 25" deep shall be incorporated on the apparatus right side ahead of the rear wheels.

The compartment shall include the following:

Unistrut Tracking

E45 Series LED strip lights to illuminate the entire area. The lights shall run the entire height of the compartment on each side of the door opening.

R2

One (1) compartment with a roll-up door shall be located above the wheel well on the right side. It shall have a door opening of 54" wide x 27" high x 25" deep.

The compartment shall include the following:

Unistrut Tracking

E45 Series LED strip lights to illuminate the entire area. The lights shall run the entire height of the compartment on each side of the door opening.

R3

A roll-up door compartment assembly with a door opening of 54" wide x 64" high x 25" deep shall be



incorporated on the apparatus right side behind the rear wheels.

The R3 compartment shall extend to the rear body panel.

The compartment shall include the following:

Unistrut Tracking

E45 Series LED strip lights to illuminate the entire area. The lights shall run the entire height of the compartment on each side of the door opening.

REAR COMPARTMENT SHALL BE AS FOLLOWS:

A roll-up door compartment assembly with a door opening of 43" wide x 55" high x 29" deep shall be located at the rear of the apparatus.

TRANSVERSE OPENING:

The side compartments behind the wheel shall be made transverse or interconnecting with the rear compartment. This transverse compartment will be full body width and must be accessible from the left side, right side or the rear compartment area.

The rear compartment shall include the following:

E45 Series LED strip lights to illuminate the entire area. The lights shall run the entire height of the compartment on each side of the door opening.

PIKE POLE TUBE:

Two (2) pike pole tube(s) shall be installed in the ladder storage compartment.

LADDER AND SUCTION HOSE STORAGE:

The ladders and suction hose shall be stored in a compartment located through the booster tank. The compartment shall be manufactured of poly material and shall be accessible from the rear compartment of the apparatus through the rear roll up door.

ATTIC LADDER BRACKET:

One (1) attic ladder bracket shall be provided. It shall have the capacity to carry an attic ladder.



Abrasion pads shall be installed to prevent body finish damage.

The ladder storage shall have the capacity to contain the following:

One (1) 24' 2-Section Ladder

One (1) 14' Roof Ladder with Hooks

One (1) 10' Attic Ladder

Two (2) 10' Length(s) of Hard Suction Hose

Two (2) Pike Pole(s)

UPPER STORAGE COMPARTMENTS:

There shall be two (2) storage compartments located on the roof of the apparatus, with one (1) on each side. The compartments shall be recessed into the roof of the unit, with only the lift up door extending above the roofline. Each compartment shall incorporate a lift up shoebox style door with positive hold open device and two (2) quarter turn latches. The compartments shall be watertight and incorporate drain lines to drain any moisture to the underside of the apparatus. The drains shall have tubing extending to the underside of the truck.

Each compartment shall incorporate a compartment light as specified below. The lights shall be switched to automatically illuminate whenever the compartment doors are in the open position. The compartment doors shall be wired to the hazard light in the chassis cab to alert the driver when the doors are in the open position.

DURATILE TILE ON FLOOR:

The floor of each coffin compartment shall be covered with black Duratile Tile.

E45 Series LED strip lighting to illuminate each upper storage compartment. The lights shall run the entire length of the compartment on one (1) side of the door opening.

RUB RAILS:

Bolt on aluminum rub rails shall be installed, below the compartment doors. Said rub rails will be fabricated of a polished "C" channel aluminum, mounted to the body surface utilizing 1/4" plastic spacers.

The rub rails shall incorporate the LED ground lights and LED lower warning lights. Each light strip shall run the full length of each rub rail.

The channel designed rub rail shall incorporate a highly reflective red and fluorescent yellow green reflective stripe to aid in apparatus protection.

STAINLESS STEEL TOP ACCESS LADDER:

One (1) Sure-Grip Stainless steel access ladder shall be provided at the rear of the apparatus. Sure-Grip is a collapsible, self-retracting ladder that provides safety and security while ascending or descending. The ladder stores in a low profile position parallel to the truck body. To use, the bottom section simply flips down and the ladder pulls out to a comfortable climbing angle. When finished, the bottom section flips up and locks in place.

The Sure-Grip Ladder is constructed of stainless steel and uses stainless hardware to provide dependable use in all environments. The ladder side rails are powder coated grey and each star punched stainless steel step shall remain natural #4 finish. Sure-Grip Ladder is designed to meet all NFPA standards.

Integrated hand holes are provided on each rail to assure safe climbing.

LOCATION: Left Side

DURATILE TILE ON FLOOR:

The floor of each main body compartment shall be covered with black Duratile Tile.

VERTICAL UNISTRUT IN COMPARTMENT:

The unistrut tracking as previously specified shall be vertically installed on the compartment walls for use with adjustable shelving. The tracking will allow the shelving to be adjustable to height with an eight (8) bolt lock. The tracking shall be installed from the floor of the compartment to approximately 4" below the ceiling of the compartment, allowing full height adjustability.

TANK:

BOOSTER TANK:

The tank shall have a capacity of 1000 US gallons complete with a lifetime warranty.

The tank shall be constructed of ½" thick PT2E polypropylene sheet stock. This material shall be non-

corrosive stress relieved thermo-plastic and U.V. stabilized for maximum protection.

The booster tank shall be of a specific configuration and so designed to be completely independent of the body and compartments. All joints and seams shall be nitrogen welded and tested for maximum strength and integrity. The transverse swash partitions shall be manufactured of 3/8" PT2E polypropylene (natural in color) and extend from approximately 4" off the floor to just under the cover. The longitudinal swash partitions shall be constructed of 3/8" PT2E polypropylene (natural in color) and extend from the floor of the tank through the cover to allow for positive welding and maximum integrity. All partitions shall be equipped with vent and air holes to permit movement of air and water between compartments. The partitions shall be designed to provide maximum water flow. All swash partitions interlock with one another and are welded to each other as well as to the walls of the tank.

FILL TOWER AND COVER

The tank will have a combination vent and manual fill tower. The fill tower will be constructed of 1/2" PT2E polypropylene and shall be a minimum dimension of 8" x 8" outer perimeter. The tower will be located in the left front corner of the tank. The tower will have a 1/4" thick removable polypropylene screen and a PT2E polypropylene hinged type cover. Inside the fill tower, approximately 4" down from the top, shall be fastened a combination vent overflow pipe. The vent overflow shall be a minimum of schedule 40 polypropylene pipe with a minimum I.D. of 4" that is designed to run through the tank and shall be piped behind the rear wheels.

The tank cover is constructed of 1/2" thick PT2E polypropylene and UV stabilized, to incorporate a multi three-piece design which allows for individual removal and inspection if necessary. The tank cover will be recessed 3/8" from the top of the tank and shall be welded to both sides and longitudinal partitions for maximum integrity. Each one of the three covers will have hold-downs consisting of 2" polypropylene dowels spaced a maximum of 30" apart. These dowels will extend through the covers and be welded to the transverse partitions. This will assist in keeping the cover rigid under fast filling conditions. A minimum of two (2) lifting dowels shall be drilled and tapped 1/2" x 13" to accommodate the lifting eyes.

SUMP

There will be one (1) sump standard per tank. The sump shall be constructed of 1/2" PT2E polypropylene and be located in the left front quarter of the tank. The sump will have a minimum 3" NPT threaded outlet on the bottom for a drain plug. This shall be used as a combination cleanout and drain. All tanks shall have an anti-swirl plate located approximately 2" above the sump.

OUTLETS

There will be two (2) standard tank outlets: one for the tank to pump suction line which will be a



minimum of a 3" NPT coupling and one for a tank fill line which will be a minimum of a 2" NPT coupling. All tank fill couplings will be backed with flow deflectors to break up the stream of water entering the tank, and be capable of withstanding sustained fill rates of up to 1000 GPM. All auxiliary outlets and inlets must meet all NFPA guidelines in effect at the time of manufacture.

MOUNTING

The tank shall rest on the body cross members with an unsupported area not to exceed 530 sq. inches on tanks up to 40" in height. On tanks over 40" in height, an unsupported area of not more than 400 sq. inches must be maintained. All tanks shall be isolated from the cross members through the use of hard rubber strips with, a minimum thickness and width dimension of .250 x 2" and a minimum Rockwell hardness of 60 durometer. Additionally, the tank must be supported around the entire bottom outside perimeter and captured both front and rear as well as side to side to prevent the tank from shifting during vehicle operation. A picture frame type cradle mount shall be utilized with a minimum of 2" x 2" x .250 structural material.

Although the tank is designed on the free-floating suspension principle, it shall be required that the tank have hold down restraints half way between the front and the rear of the tank. These restraints shall be made of 3" x 3" x 1/4" angle approximately 6" long. The restraints shall be mounted to the side walls of the hose bed and extend down so that they rest approximately 1/2" above the top of the tank. The tank shall be completely removable without disturbing or dismantling the apparatus structure.

Upon final apparatus delivery, proper evidence and certifications shall be presented indicating the tank has the capacity of flow to the pump 80% of its rated capacity at a flow rate of 1000 GPM.

12 VOLT ELECTRICAL:

ELECTRICAL WARRANTY:

Alexis Fire Equipment Co., Inc. warrants each new piece of Alexis fire and rescue apparatus to be free from defects in material and workmanship under normal use and service. Our obligation under this warranty is limited to repairing or replacing, as the company may elect, any part or parts thereof which shall be returned to us with transportation charges prepaid, and as to which examination shall disclose to the company's satisfaction to have been defective, provided that such part, or parts shall be returned to us within seven (7) years or 50,000 miles after delivery of such vehicle. Such defective part or parts will be repaired or replaced free of charge and without charge for installation to the original purchaser.

Items specifically covered are:

- Electrical harnesses and harness installation
- Printed circuit board

- Switches, circuit breakers and relays

Items excluded are:

- Chassis electrical systems and components installed by chassis manufacturer
- Separately manufactured items installed by Alexis Fire Equipment including, but not limited to; batteries, sirens, battery chargers, inverters, lightbars and similar equipment. (These are covered by warranties supplied by the manufacturer of the components).
- Periodic tightening and cleaning of connection terminals as this is considered routine maintenance
- Normal wear, abuse, accident, negligence or un-approved alteration of original parts.

Should repairs become necessary under the terms of this warranty, the extent of that repair shall be determined solely by Alexis Fire Equipment and shall be performed solely by Alexis Fire Equipment or a repair facility designated by Alexis. The expense of any transportation to or from such repair facility shall be that of the purchaser and is not an item covered by this warranty.

Alexis Fire Equipment reserves the un-restricted right at any time to make changes in design of and/or improvements on its products without thereby imposing any obligation on itself to make corresponding changes or improvements in or on its products theretofore manufactured.

12 VOLT ELECTRICAL SYSTEM:

Our electrical system is engineered to provide many years of dependable, trouble free service.

The 12 volt apparatus wiring shall be completely independent of the chassis electrical system. The system shall incorporate a state-of-the-art electrical distribution center. The center shall include a microprocessor, automatic reset circuit breakers, and switching relays.

The microprocessors are housed in a weather resistant enclosure. All processors are fully tested, and modern production processes guarantee long-term reliability in the most rigorous environments. The microprocessors handle the numerous switching functions without the excessive use of relays and the need for excess wiring.

The system can be expanded by adding additional processors and required components to meet desired specifications.

The weather tight modular service center shall be placed in a water-tight compartment in the apparatus body. The service center housing shall be manufactured of aluminum and shall incorporate an access door. Since the microprocessor is of weather resistant design and enclosed in the service center, the electrical system has redundant protection against moisture and corrosion. Redundant protection from

the elements dramatically improves reliability and durability.

Wiring harnesses shall be custom made for each truck. Each harness shall be encased in a split barrel, nylon type loom which will be moisture resistant and flame resistant to a minimum of 280° F. Loop outs shall be made at the harness factory utilizing sealed sonic weld technology instead of open-ended butt splicing. The harnesses shall feature Deutsch heavy duty all metal connectors.

Unlike terminal strips, binding post and other open-wiring systems, the Deutsch HD series is a completely sealed unit. The elimination of open wiring systems does away with contamination from moisture, dust, lubricating oils, road salt, and other environmental hazards encountered in heavy duty use. The connector shall provide a multiple keying system that positively prevents mis-mating and makes plug/receptacle coupling quick and easy. The modular harness system will allow for quick and efficient complete body transfer if needed.

An independent switching station shall be centrally located in the apparatus cab. The switches shall be of a rocker type illuminating design. Each switch shall be color coded, and include a description indicating its intended use. Each switch shall be removable for service and replacement. Each switch shall be rated at 10 amp at 250 volts AC and shall act as inputs for the microprocessor.

All electrical circuit feeder wiring supplied and installed by the apparatus manufacturer shall be stranded copper alloy conductors of a gauge rated to carry 125% of the maximum current for which the circuit is protected. Insulation shall be in accordance with SAE J1128, low tension primary cable, type SXL or GXL, and wired to SAE J1292, automobile, truck, truck-tractor, trailer and motor coach wiring, for such loading at the potential employed. Voltage drops in all wiring from the power source to the using device shall not exceed 10%. Overall covering of conductors shall be 280° F (143° C) minimum flame retardant, moisture resistant loom or braid. All connections shall be made with lugs or terminals mechanically secured to the conductors. Wiring shall be thoroughly secured in place and suitably protected against heat, oil, and physical damage. Wiring shall be color coded and printed with a circuit function code over each conductor's entire length.

Circuits shall be provided with properly rated low voltage over-current protective devices. Such devices shall be readily accessible and protected against excessive heat, physical damage and water spray, switches relays, terminals, and connectors shall have a direct current rating of 125% of maximum current for which the circuit is protected.

Wiring Diagrams: Two (2) destination effective wiring diagrams shall be furnished with the apparatus. The wiring diagrams shall incorporate notations to assist an individual with limited electrical experience in the service of the apparatus electrical system.

NOTE: All wiring and components shall meet or exceed current N.F.P.A. codes.

LOAD MANAGEMENT:

The 12 volt load management functions shall be incorporated within the microprocessor based 12 Volt electrical system without the need for a separate load manager.

12 VOLT DISTRIBUTION CENTER:

The 12 Volt distribution center shall be located in the L1 compartment on the front wall, behind an access panel. The access panel shall incorporate a laminated wiring diagram for ease of maintenance of the electrical system.

A 12 volt fan shall be provided in the distribution center to enhance the air flow around the electrical equipment. The fan shall be switched with the master switch.

ELECTRICAL SYSTEM PERFORMANCE TESTS:

The apparatus low voltage electrical system shall be tested and certified per the current NFPA standard. The certification shall be delivered to the purchaser with the apparatus.

DOCUMENTATION:

At the time of delivery, the manufacturer shall provide the following:

- (a) Documentation of the electrical system performance tests;
- (b) A written load analysis, including:
 - 1. The nameplate rating of the alternator;
 - 2. The alternator rating;
 - 3. Each component load comprising the minimum continuous load;
 - 4. Additional loads that, when added to the minimum continuous load, determine the total connected load;
 - 5. Each individual intermittent load.

RADIO:

One (1) radio(s) shall be installed by the customer after receipt of the completed apparatus.

No radio wiring shall be supplied in the console area.



OPTICAL WARNING SYSTEM:

The optical warning system on the fire apparatus shall be capable of two separate signaling modes during emergency operations. One mode shall signal to drivers and pedestrians that the apparatus is responding to an emergency and is calling for the right-of-way. The other mode shall signal that the apparatus is stopped and is blocking the right-of-way.

EMERGENCY WARNING LIGHTS:

For the purpose of defining and measuring the required optical performance, the apparatus shall be divided into four warning zones. The four zones shall be determined by drawing lines through the geometric center of the apparatus at 45° to a line lengthwise of the apparatus through the geometric center. The four zones shall be designated A, B, C, and D in a clockwise direction with zone A to the front of the apparatus. Each zone shall have an upper and lower warning level.

Effective coverage of all four zones, both upper and lower, as required by the latest NFPA Edition shall be provided.

LIGHTBAR:

The lightbar shall be supplied on the chassis by the chassis manufacturer.

WARNING LIGHTS (FRONT):

The chassis supplied Whelen 600 series warning lights shall be removed and replaced with two (2) Tecniq Model K60-R*00-1 Red LED warning lights.

Each light shall incorporate a colored lens.

WARNING LIGHTS (SIDE):

The chassis supplied Whelen Model 60 intersection warning lights on the bumper sides shall be removed and replaced with two (2) Tecniq Model K60-R*00-1 Red LED warning lights.

Each cab side light shall be mounted utilizing a chrome plated flange.

Each light shall incorporate a colored lens.

WARNING LIGHTS (SIDE):

The rub rails on each side of the body shall incorporate integral outward facing Red LED strip lights. In addition to the Red LED strip light, the rub rail on each side ahead of the rear wheels shall incorporate one (1) TecNiq E03-D001-1 LED light. These lights shall be switched from the in cab switch panel.

WARNING LIGHTS (SIDE):

Two (2) Tecniq Model K90-R*00-1 Red LED warning lights shall be mounted on the right (officer's) side of the vehicle in the upper area. These lights shall be switched from the in cab switch panel.

Two (2) Tecniq Model K90-R*00-1 Red LED warning lights shall be mounted on the left (driver's) side of the vehicle in the upper area. These lights shall be switched from the in cab switch panel.

These lights fill the requirements of Zones B & D Upper.

Each light shall be mounted utilizing a chrome plated flange.

Each light shall incorporate a colored lens.

WARNING LIGHTS (REAR UPPER):

Two (2) Tecniq Model K90-R*00-1 Red LED lights shall be mounted on the rear of the vehicle, in the upper area. The lights shall be switched from the in cab switch panel. These lights fill the requirements of Zone C Upper.

Each light shall be mounted utilizing a chrome plated flange.

Each light shall incorporate a colored lens.

WARNING LIGHTS (REAR):

Two (2) Tecniq Model K60-R*00-1 Red LED warning lights shall be mounted on the lower rear area of the vehicle. These lights shall be switched from the in cab switch panel. These lights fill the requirements of Zone C Lower.

Each light shall be mounted utilizing a chrome plated flange.

Each light shall incorporate a colored lens.

REAR DRIVING SIGNALS:

The rear driving signals shall consist of two (2) Code 3 7X9STTRBZ LED lights, one (1) each side of the apparatus at the rear. The 7X9 LED lights shall incorporate red brake/tail, amber turn, and white backup in a single light head. The mounting shall include a chrome bezel.

TURN SIGNALS-MIDSHIP:

One (1) S34 Series amber LED midship turn light shall be mounted on each side of the apparatus ahead of the rear wheels.

ICC LIGHTING:

Tecniq S34 Series LED Clearance lights shall be installed on the apparatus. They shall be hermetically sealed cartridge lights for ease of service and durability.

LED REAR LICENSE PLATE BRACKET:

There shall be a Cast Products LED license plate bracket provided at the rear of the apparatus.

PUMP COMPARTMENT LIGHT:

One (1) 5" T44 Series LED light shall be installed in the pump compartment. The light shall be switched with pump panel lights.

HAZARD LIGHT:

A red, LED flashing light located in the driving compartment shall be illuminated automatically whenever the apparatus parking brake is not fully engaged and any passenger or equipment compartment door is open, any ladder or equipment rack is not in the stowed position, a stabilizer system is deployed, a powered light tower is extended, or any other device is opened, extended, or deployed that creates a hazard or is likely to cause damage to the apparatus if the apparatus is moved. The light shall be marked "Do Not Move Apparatus When Light Is On".

LED COURTESY LIGHTS (UNDER CARRIAGE LIGHTING):

One (1) 5" 12-volt T44 Series LED light shall be located under each cab door and one (1) shall be located below the rear tail step in the center. All ground area lighting shall be controlled by the master switch and shall be switched with the parking brake.

In addition to the 5" lights, clear LED strip lights shall be provided integral to the rub rails on each side. The strip lights shall face downward and be activated with the balance of the undercarriage lighting.



LED TAILBOARD COURTESY LIGHTS:

Two (2) S34 Series LED courtesy lights shall be mounted one (1) each side low on the rear panel. The lights shall illuminate the rear tailboard. They shall be switched with the parking brake.

LED RUNNING BOARD COURTESY LIGHTS:

One (1) S34 Series LED courtesy light shall be mounted on each side low on the front of the body. Each light shall illuminate the running board area. The lights shall be switched with the parking brake.

FIRETECH 12-VOLT LED SCENE LIGHT(S):

Two (2) FireTech FT-MB-2.18-FT-* Double Stack 21" 19,008 lumen LED bar scene light(s) shall be mounted in the specified location(s). The lights shall be switched from the in-cab switching station.

Each Firetech Hi-Viz scene light bar shall be recessed mounted in the specified location

Each Firetech Hi-Viz scene light shall be white in color.

SIDE SCENE LIGHT LOCATION(S): One (1) Each Side

FIRETECH 12-VOLT LED SCENE LIGHT(S):

Two (2) FireTech Model FT-GESM 12-volt 20,000 Lumen LED surface mounted scene light(s) mounted in the specified location(s). The lights shall be switched from the in-cab switching console.

Each light shall be mounted utilizing a chrome plated flange.

REAR SCENE LIGHT LOCATION(S): One (1) Each Side

HOSEBED STRIP LIGHTING - LED:

Two (2) E45 Series LED Strip lights shall be provided at the front of the apparatus hose bed. The lights shall be switched with the parking brake.

BACK-UP CAMERA INSTALLATION:

The chassis supplied back-up camera shall be installed in the rear body panel, above the rear compartment door.

BRACKETING:

INTERMEDIATE REAR STEP:

A 45" wide intermediate rear step constructed of 12 gauge star punch stainless steel material shall be located at the rear of the apparatus below the hose bed. The step shall be 8" deep.

The intermediate rear step shall incorporate a cutout in the center for backup camera mounting, if applicable.

GRAB HANDLE:

One (1) 48" knurled bright stainless steel 1¼" O.D. grab rail shall be installed vertically on the rear of the body.

Each grab handle shall have a natural stainless steel finish

GRAB HANDLES:

Two (2) 12" knurled bright stainless steel 1¼" O.D. grab handles shall be installed at the on the face of the rear intermediate step, outboard on each side

Each grab handle shall have a natural stainless steel finish

GRAB HANDLES:

Two (2) 12" knurled bright stainless steel 1¼" O.D. grab handles shall be installed on the top of the compartments at the rear of the apparatus, one (1) each side.

Each grab handle shall have a natural stainless steel finish

WHEEL CHOCKS:

One (1) pair of Ziamatic #2-SAC-44 folding wheel chocks shall be provided with the apparatus. The chocks shall be mounted in a location that is easily accessible.

FINISH:

APPARATUS BODY FINISH:

The final finish of the apparatus shall conform to fire apparatus standards, exhibiting excellent gloss durability and color retention properties.

PREPARATION:

Since the removal of all contaminants and oxidation is essential to the final effect of a finish system, the apparatus shall be pre-cleaned with wax and grease remover and towel dried prior to evaporation.

A 10-step standard body preparation shall be completed.

When the substrate is prepared, the entire body shall be cleaned by washing again with wax and grease remover and towel dried.

PRETREAT AND PRIMERS:

The pretreat and primer applications shall be made in two (2) independent steps. A application of a combined pretreat/primer product will not be allowed as a substitute.

The prepared substrate shall be pretreated with Acid Curing 2 Component Transparent Primer. This pretreat shall be designed to provide corrosion protection and to create an adhesive bond between the substrate and the surface applications.

To enhance adhesion and top coat gloss, a 2 component epoxy primer shall be applied.

All the primed surfaces shall be sanded smooth, thus removing all texture and surface imperfections and creating a finish base that will meet the rigid requirements of the fire and emergency services.

TOP COATS:

Two (2) coats (0.5 - 2.0 mils) urethane base coat shall be applied in a professional manner. After the base coats have cured properly, two (2) coats of a high solids urethane clear coat shall be applied.

All surface imperfections shall be removed by buffing and polishing.

PAINT WARRANTY:

The apparatus shall be covered by a ten -(10) year paint warranty. Following are the covered defects and exclusions.

Covered Defects shall include only the following list of defects:

- Peeling or delaminating of the topcoat and/or other layers of paint.
- Cracking or checking.
- Loss of gloss caused by cracking, checking or hazing.

Defects resulting from the following conditions are excluded from the Warranty:

- Hazing, chalking or loss of gloss caused by improper care, abrasive polishes, cleaning agents, heavy-duty pressure washing, or aggressive mechanical wash systems
- Rock chips are not covered under this warranty.
- Paint deteriorating caused by abuse, scratches, chips, gloss reduction, accidents, acid rain, chemical fallout or acts of nature
- Claims presented without proper Warranty documentation
- Failure on finishes performed by Non-PPG Commercial Certified Technicians
- Failures on finishes due to inadequate film builds
- Failures due to improper cleaning or surface preparation or failure to follow the product use instructions

COMPARTMENT INTERIOR FINISH:

The interior of the compartments shall be natural finish stainless steel

APPARATUS COLOR:

The color of the apparatus shall be as follows:

COLOR: _____

CAB LETTERING:

Vinyl lettering as described below shall be applied to the chassis cab door, one (1) each side. Each letter shall be 2½" to 3½" high and hand applied.

Vinyl letters/numbers shall be applied to the chassis cab fender area, one (1) each side. Each letter/number shall be 2½" to 3½" high and hand applied.

The lettering vinyl style shall be simulated gold leaf.

The lettering font style shall be Eurostile Bold.



The lettering font highlight type shall be shadow.

LAMINATION WARRANTY:

The apparatus shall be covered by a three (3) year warranty against defects in material and workmanship with the graphics process

REFLECTIVE STRIPING:

The finished apparatus shall be striped with 6" reflective Scotchlite striping.

The reflective striping shall be white in color.

DIAMOND GRADE CHEVRON STRIPING:

The rear of the apparatus shall be striped with Diamond Grade retro-reflective striping. The striping shall be applied in a chevron pattern sloping downward and away from the centerline of the apparatus at a 45° angle. The striping shall be applied in the following locations: vertical surfaces between the body panels at the rear, from the tailstep walkway to the hose bed

Diamond Grade Striping in a Chevron pattern shall also be installed on the rear face of the compartments on each side.

The striping shall be single color alternating between red #3992 and fluorescent yellow-green #3983.

EQUIPMENT:

One (1) Duo-Safety #10-585A aluminum folding 10' attic ladder(s).

One (1) Duo-Safety 14-775A, 14' Roof Ladder(s) with hooks.

One (1) Duo-Safety #24-900A, 24' 2 Section ground ladder(s).

Two (2) 10' Length(s) of 6" diameter hard suction hose, coupled 6" LHF x 6" RLM. (Not rated for hydrants)

NFPA EQUIPMENT CLARIFICATION:



 Alexis Fire Equipment
109 East Broadway / Alexis, IL 61412
 800-322-2284  sales@alexisfire.com
 AlexisFire.com

Any equipment specified in the “Minor Equipment” section (e.g. hose, nozzles, adapters, AED, traffic cones, traffic safety vests, etc.) of NFPA 1901 for each apparatus classification (see below) which is not specified in this proposal shall be considered to be customer supplied and installed.

Apparatus Type	NFPA Section
Pumper	5.8
Initial Attack	6.7
Mobile Water Supply	7.7
Aerial	8.8
Quint	9.8
Special Service	10.5
Mobile Foam	11.9

Quotation

		Description	Spec Page	
VEHICLE				
S	0100-020	MODEL	FC-94	12
O	8012-022	CUSTOMERS / OEMS	Alexis Fire (08900)[1000004]	
S	8011-024	MODEL YEAR	Model Year - 2024	12
S	8001-001	COUNTRY OF SERVICE	Country of Service United States Of America	12
S	8017-001	CAB AND CHASSIS LABELING LANGUAGE	Cab and Chassis Labeling Language English	12
S	8006-009	APPARATUS TYPE	Apparatus Type Pumper	12
S	8008-001	VEHICLE TYPE	Vehicle Type Straight Truck	12
S	8008A-000	VEHICLE ANGLE OF APPROACH PACKAGE	Vehicle Angle of Approach NFPA Minimum 8.00 Degrees	12
S	0104-001	AXLE CONFIGURATION	Axle Configuration 4x2 (Rear Axle Drive Only)	13
O	0101-004	GROSS AXLE WEIGHT RATINGS FRONT	GAWR Front 21500#	13
O	0102-016	GROSS AXLE WEIGHT RATINGS REAR	GAWR Rear 31500#	13
S	8010-201	PUMP PROVISION	Pump Provision Driveline Midship, Pump Mode Prog w/Auto Park Brake "N"	13
O	8009-013	WATER & FOAM TANK CAPACITY	Water & Foam Tank Capacity 750 to 1250 Gallons	13
CAB				
S	1000-004	CAB STYLE	Cab Style MFD 10" Raised Roof	13
S	1501-018	CAB FRONT FASCIA	Cab Frt Fascia Classic w/Quad Headlight Bezels	15
S	1518-060	FRONT GRILLE	Cab Frt Grille FC-94	15
S	1551-002	CAB UNDERCOAT	Cab Undercoat	15
S	1552-002	CAB SIDE DRIP RAIL	Cab Side Drip Rail	15
S	1521-001	CAB PAINT EXTERIOR	Cab Paint Exterior Single Color	15
O	1533-001	CAB PAINT PROCESS/MANUFACTURER	Cab Paint Process/Manufacturer PPG	15
O	1522-244	CAB PAINT PRIMARY/LOWER COLOR	Cab Paint Primary/Lower Color PPG White FBCH 2185	16
S	8013-054	CAB PAINT WARRANTY	Cab Paint Warranty (1) Year RFW0701	16
S	1334-036	CAB PAINT INTERIOR	Cab Paint Int Multi-tone Silver Gray	16
S	1005-001	CAB ENTRY DOORS	Cab Entry Doors (4)	16
S	1101-102	CAB ENTRY DOOR TYPE	Cab Entry Door Type Barrier Free w/Pollak Switches	16
S	1322-007	CAB INSULATION	Cab Insulation Nonwoven Polyester Fiber	17
S	8004-032	CAB STRUCTURAL WARRANTY	Cab Structural Warranty (5) Year RFW0601	17
S	9001-006	CAB TEST INFORMATION	Cab Test Information Crash Test ECE-R29/SAE J2420/SAE J2422	17
ELECTRICAL POWER DISTRIBUTION				
S	5000-018	ELECTRICAL SYSTEM	Elec System 12V DC Multiplex	17

S	5622-003	DATA RECORDING SYSTEM	Data Recording Sys Vehicle Data Weldon MUX	17
S	5004-002	LOAD MANAGEMENT SYSTEM	Load Management System Multiplex	18
S	5031-005	ACCESSORY POWER	Accessory Pwr & Gnd Stud 40A Batt Dir & 15A Ign Sw & 225A Batt Dir OEM Conn	18
S	5011-001	EXTERIOR ELECTRICAL TERMINAL COATING	Exterior Electrical Terminal Coating Spray On Plasti Dip	18
S	8014-001	ELECTRICAL SYSTEM WARRANTY	Electrical System Warranty (1) Year RFW0201	18

ENGINE

O	1701-168	ENGINE	Engine Diesel 450HP Cummins L9 - EPA 2021	18
S	1329-001	CAB ENGINE TUNNEL	Cab Engine Tunnel Small/Medium	19
S	1731-002	DIESEL PARTICULATE FILTER CONTROLS	DPF Ctrl Regeneration Sw & Inhibit Sw	19
S	1718-002	ENGINE PROGRAMMING HIGH IDLE SPEED	Engine Programming High Idle Speed 1250 RPM	19
S	1719-004	ENGINE HIGH IDLE CONTROL	Engine High Idle Ctrl Manual and Automatic	19
S	1710-001	ENGINE PROGRAMMING ROAD SPEED GOVERNOR	Engine Programming Road Speed Governor Enabled	19
O	1713-010	AUXILIARY ENGINE BRAKE	Aux Engine Brake Compression Brake w/VG Turbo	19
O	1708-004	AUXILIARY ENGINE BRAKE CONTROL	Aux Engine Brake Ctrl On/Off & Low/Med/High Sw Pnl	20
S	1720-003	ELECTRONIC ENGINE OIL LEVEL INDICATOR	Elec Engine Oil Level Indicator	20
S	1715-008	FLUID FILLS	Fluid Fills Under Cab	20
S	1735-001	ENGINE DRAIN PLUG	Engine Drain Plug	20
S	8002-001	ENGINE WARRANTY	Engine Warranty Cummins (5) Year/100,000 Miles	20
S	1707-116	REMOTE THROTTLE HARNESS	Rmt Throttle Harness Cab Harness Only Shift Interlock	20
S	1721-001	ENGINE PROGRAMMING REMOTE THROTTLE	Engine Program Rmt Throttle Off	21
S	1727-001	ENGINE PROGRAMMING IDLE SPEED	Engine Programming Idle Speed 700 RPM	21

AIR INTAKE

S	2801-010	ENGINE AIR INTAKE	Engine Air Intake Filtration and Restriction w/Replaceable Element Abv Radiator	21
---	----------	--------------------------	---	----

COOLING

O	2704-018	ENGINE FAN DRIVE	Engine Fan Drive Variable Speed Engaged in Pump Mode	21
S	2701-021	ENGINE COOLING SYSTEM	Engine Cooling System Serial Flow w/Package Drop-Out Prov	21
S	2711-002	ENGINE COOLING SYSTEM PROTECTION	Engine Cooling System Protection Light Duty Skid Plate	22
S	2708-001	ENGINE COOLANT	Engine Coolant Extended Life	22
S	2706-003	ELECTRONIC COOLANT LEVEL INDICATOR	Elec Low Coolant Level Indicator	22
S	2705-002	ENGINE PUMP HEAT EXCHANGER	Engine Pump Heat Exchanger	23
S	2709-001	COOLANT HOSES	Coolant Hoses Silicone	23
S	2710-005	ENGINE COOLANT OVERFLOW BOTTLE	Engine Coolant Overflow Expansion Bottle	23

EXHAUST

S	2901-067	ENGINE EXHAUST SYSTEM	Eng Exhaust Sys Under Frm RH Single Module Aftertreatment Outboard	23
O	2907-003	DIESEL EXHAUST FLUID TANK	Diesel Exhaust Fluid Tank LH 6 Gal Fill Thru Rr Step	23
S	2902-010	ENGINE EXHAUST ACCESSORIES	Engine Exhaust Acc Temp Mitigation	24
S	2906-002	ENGINE EXHAUST WRAP	Engine Exhaust Wrap	24
S	8018-002	EMISSIONS SYSTEM WARRANTY	Emissions System Warranty (5) Year/100,000 Miles RFW0140	24

TRANSMISSION

S	1801-015	TRANSMISSION	Transmission Allison 3000 EVS	24
S	1806-001	TRANSMISSION MODE PROGRAMMING	Transmission Mode Programming 4th Startup/5th Mode	24
S	1811-004	TRANSMISSION FEATURE PROGRAMMING	Transmission Feature Programming Allison Gen 5 & 6-E I/O Package 198/Pumper	24
S	1815-002	ELECTRONIC TRANSMISSION OIL LEVEL INDICATOR	Elec Transmission Oil Level Indicator	25
S	1807-005	TRANSMISSION SHIFT SELECTOR	Transmission GEN 5 & 6-E Shift Sel Key Pad/Push Button	25
S	1814-002	TRANSMISSION PRE-SELECT WITH AUXILIARY BRAKE	2nd Gear Pre-Select	25
S	1808-007	TRANSMISSION COOLING SYSTEM	Transmission Cooling System	25
S	1817-001	TRANSMISSION DRAIN PLUG	Transmission Drain Plug	26
S	8005-001	TRANSMISSION WARRANTY	Transmission Warranty Allison (5) Year	26

POWER TAKE OFF

S	2005-009	PTO LOCATION	PTO Location 8:00/4:00	26
---	----------	---------------------	------------------------	----

DRIVELINE

S	3001-014	DRIVELINE	Driveline MSI 1710 w/Meritor U-Joints w/Thrust Washers	26
S	3005-002	MIDSHIP PUMP / GEARBOX	Midship Pump Jackshaft Only	26
O	3008-008	MIDSHIP PUMP / GEARBOX MODEL	Midship Pump/Gearbox Model Hale DSD Fwd	26
S	3048-004	MIDSHIP PUMP GEARBOX DROP	Midship Driveline Pump Gearbox Drop Hale "LG"	26
S	3009-020	MIDSHIP PUMP RATIO	Midship Pump Ratio 2.28:1 (23)	26
S	3010-1020	MIDSHIP PUMP LOCATION C/L SUCTION TO C/L REAR AXLE	Midship Pump Location C/L Suction to C/L Rear Axle 102.0"	26
S	5013-032	PUMP SHIFT CONTROLS	Pump Shift Ctrl Air Ctrl Integrated Shifter Pod	26
S	3049-003	PUMP SHIFT CONTROL PLUMBING	Pump Shift Control Plumbing Pre-Plumb Elec/Air	27

FUEL SYSTEMS

S	3109-067	FUEL FILTER/WATER SEPARATOR	Fuel Filter/Wtr Separator Fleetguard FS20121 w/Lt & Alarm	27
S	3111-001	FUEL LINES	Fuel Lines Nylon	27
S	3103-008	ELECTRIC FUEL PRIMER	Electric Fuel Primer Engine Sply Electric Lift Pump	27
S	3101-101	FUEL TANK	Fuel Tank 50 Gallon	27
S	3130-001	FUEL TANK MATERIAL AND FINISH	Fuel Tank Material Steel & Finish Painted Frame Components Color	28
S	3131-001	FUEL TANK STRAP MATERIAL AND	Fuel Tank Strap Material Steel & Finish Painted Frame	28

	FINISH	Components Color	
S	3102-007	FUEL TANK FILL PORT	Fuel Tank Fill Port LH Rwd/RH Mid 28
S	3115-002	FUEL TANK DRAIN PLUG	Fuel Tank Drain Plug Magnetic 28

FRONT AXLE

O	2401-004	FRONT AXLE	Frt Axle Meritor MFS 21500# Beam 28
S	8059-022	FRONT AXLE WARRANTY	Front Axle Warranty Meritor 2024 28
S	2405-001	FRONT WHEEL BEARING LUBRICATION	Frt Wheel Bearing Lube Oil 29

FRONT SUSPENSION

S	2502-002	FRONT SHOCK ABSORBERS	Frt Shock Absorbers Bilstein 29
O	2501-016	FRONT SUSPENSION	Frt Suspension 10 Leaf 20000-21500# 29

STEERING

S	2601-005	STEERING COLUMN/WHEEL	Steering Column/Wheel Tilt/Telescopic 18" 2 Spoke 29
S	2609-002	ELECTRONIC POWER STEERING FLUID LEVEL INDICATOR	Elec Power Steering Fluid Level Indicator 29
S	2603-011	POWER STEERING PUMP	Power Steering Pump TRW w/Passive Cooler 29
O	2606-009	FRONT AXLE CRAMP ANGLE	Front Axle Cramp Angle 48L/44R Degrees 30
O	2610-003	POWER STEERING GEAR	Power Steering Gear TRW TAS 65 w/Assist 30
S	2608-001	CHASSIS ALIGNMENT	Chassis Alignment 30

REAR AXLE

O	3401-014	REAR AXLE	Rear Axle 33000# Meritor RS-30-185 30
S	3403-001	REAR AXLE DIFFERENTIAL LUBRICATION	Rear Axle Differential Lubrication Oil 30
S	8061-019	REAR AXLE WARRANTY	Rear Axle Warranty Meritor 2024 30
S	3411-001	REAR WHEEL BEARING LUBRICATION	Rear Wheel Bearing Lubrication Oil 30
S	3408-008	VEHICLE TOP SPEED	Vehicle Top Speed 68 MPH 30
S	3410-001	REAR AXLE EXTERNAL VENT	Rear Axle External Vent OEM Housing Breather

REAR SUSPENSION

S	3501-032	REAR SUSPENSION	Rear Susp Reyco 79KB Spring 21000-31500# Conventional 31
---	----------	------------------------	--

TIRES

S	3625-002	TIRE INTERMITTENT SERVICE RATING	Tire Intermittent Service Ratings Acceptable 31
O	3601-083	FRONT TIRE	Frt Tire 385/65R 22.5 Michelin X Multi HL Z 31
O	3602-019	REAR TIRE	Rear Tire 315/80R 22.5 Michelin XDN2 Grip 31
O	3413-513	REAR AXLE RATIO	Rear Axle Ratio 5.13 32
S	3614-030	TIRE PRESSURE INDICATOR	Tire Pressure Ind Frt & Rr LED 32

WHEELS

O	3701-033	FRONT WHEEL	Frnt Wheel Alcoa 22.5 x 12.25 Alum	32
O	3703-053	REAR WHEEL	Rr Whl Alcoa 22.5 x 9.00 Alum	32

BRAKES

O	3205-012	BRAKE SYSTEM	Brake System ABS/ATC/ESC Sgl Axle	32
O	3206-003	FRONT BRAKES	Frnt Brakes Meritor EX225 Disc 17"	33
O	3207-009	REAR BRAKES	Rr Brakes S-Cam Drum 16.5" x 8.6" Cast Iron Shoe	33
S	3208-001	PARK BRAKE	Prk Brake Rr Wheels Only	33
S	3204-029	PARK BRAKE CONTROL	Prk Brake Ctrl LH Tunnel Mnt, Integrated w/Shift Pod, Adjacent To Trans Shifter	33
O	3214-002	REAR BRAKE SLACK ADJUSTERS	Rr Brake Slack Adjusters Haldex	33
S	3202-001	AIR DRYER	Air Dryer Wabco System Saver 1200 Bhd RH Step	33
O	3215-004	FRONT BRAKE CHAMBERS	Frnt Brake Chambers MGM Type 24 Long Stroke	34
O	3210-015	REAR BRAKE CHAMBERS	Rr Brake Chambers TSE 30/36 Long Stroke	34

AIR SUPPLY SYSTEMS

S	3320-001	AIR COMPRESSOR	Air Compressor Wabco SS318 18.7 CFM	34
S	3339-004	AIR GOVERNOR	Air Governor Mnt on Air Dryer Bracket	34
S	3303-001	MOISTURE EJECTORS	Moisture Ejectors Manual	34
S	3307-101	AIR SUPPLY LINES	Air Sply Lines Nylon w/PTC Fittings	34

FRAME

O	2103-1985	WHEELBASE	Wheelbase 198.5"	34
O	2106-0460	REAR OVERHANG	Rear Overhang 46.0"	34
O	2101-002	FRAME	Frame Double Channel 35.00" Width	35
O	2110-201	FRAME PAINT	Frame Paint Hot Dipped Galvanized - Frame Only Addl Comp Blk Powder Coat	35
S	8007-034	FRAME ASSEMBLY STRUCTURAL WARRANTY	Frame Assembly Structural Warranty (5) Year RFW0301	36
O	8019-004	FRAME RAIL CORROSION WARRANTY	Frame Rail Corrosion Warranty (10) Year RFW0317	36
S	8022-003	FRAME COMPONENTS CORROSION WARRANTY	Frame Components Corrosion Warranty (1) Year RFW0313	36

BUMPER

S	2201-001	FRONT BUMPER	Frnt Bumper Stainless Steel Flat	36
O	2202-006	FRONT BUMPER EXTENSION LENGTH	Frnt Bumper Extension Length 24"	36
O	2215-029	FRONT BUMPER SUCTION PROVISION	Frnt Bumper Suction Provision 5.0" RH Horiz Bhd Terminates Near Fascia Victaulic	36
O	2208-007	FRONT BUMPER APRON	Frnt Bumper Apron For 24" Extension	37
O	2237-004	FRONT BUMPER DISCHARGE	Front Bumper Discharge 2.0" LH Frame Mnt Plumbing	37
O	2211-003	FRONT BUMPER COMPARTMENT CENTER	Frnt Bumper Cmpt Ctr w/Cover	37
O	2210-002	FRONT BUMPER COMPARTMENT	Frnt Bumper Cmpt Cover Hardware Gas Cylinder/D-Ring	37

COVER HARDWARE

O	5503-022	MECHANICAL SIREN	Mechanical Siren Federal Signal Q2B Pedestal Mnt	37
O	2218-002	MECHANICAL SIREN LOCATION	Mech Siren Location Frt Bmpr Apron LH OB	38
O	5501-020	AIR HORN	Air Horn (2) 21" Round Hadley E-Tone	38
O	2216-010	AIR HORN LOCATION	Air Horn Location (2) Frt Bmpr Face R/L IB	38
O	2232-002	AIR HORN RESERVOIR	Air Horn Reservoir (1) 1200 Cu In	38
O	5504-029	ELECTRONIC SIREN SPEAKER	Elect Siren Speaker 100W Cast Products SA4301	38
O	2217-005	ELECTRONIC SIREN SPEAKER LOCATION	Elec Siren Speaker Location Frt Bmpr Face RH OB	38
O	2203-002	FRONT BUMPER TOW HOOKS	Frt Bumper Tow Hooks Painted Below Fwd	38

CAB TILT

S	2301-001	CAB TILT SYSTEM	Cab Tilt System	38
S	2305-001	CAB TILT CONTROL RECEPTACLE	Cab Tilt Ctrl Receptacle Temp	39
S	2306-002	CAB TILT LOCK DOWN INDICATOR	Cab Tilt Lock Down Indicator	39

CAB GLASS

S	1401-009	CAB WINDSHIELD	Cab Windshield	39
O	1402-002	GLASS FRONT DOOR	Glass Frt Dr Pwr	40
S	1407-001	GLASS TINT FRONT DOOR	Glass Tint Frt Dr Automotive Green	40
O	1419-008	GLASS REAR DOOR RIGHT HAND	Glass Rr Dr RH Pwr	40
S	1430-001	GLASS TINT REAR DOOR RIGHT HAND	Glass Tint Rr Door RH Automotive Green	40
O	1412-008	GLASS REAR DOOR LEFT HAND	Glass Rr Dr LH Pwr	40
S	1431-001	GLASS TINT REAR DOOR LEFT HAND	Glass Tint Rr Door LH Automotive Green	40
S	1410-003	GLASS SIDE MID RIGHT HAND	Glass Side Mid RH Fxd 16"W x 26"H	40
S	1432-001	GLASS TINT SIDE MID RIGHT HAND	Glass Tint Side Mid RH Automotive Green	41
S	1409-003	GLASS SIDE MID LEFT HAND	Glass Side Mid LH Fxd 16"W x 26"H	41
S	1433-001	GLASS TINT SIDE MID LEFT HAND	Glass Tint Side Mid LH Automotive Green	41

CLIMATE CONTROL

S	1614-101	CLIMATE CONTROL	Climate Ctrl Htr Defroster Frt Ovrhd/Htr A/C Tunnel Mnt	41
S	1632-002	CLIMATE CONTROL DRAIN	Climate Control Drain Gravity	41
S	1617-101	CLIMATE CONTROL ACTIVATION	Climate Ctrl Actv Device Mnt Ovrhd/Device Mnt Tunnel	41
S	1603-003	A/C CONDENSER LOCATION	A/C Condenser Location Roof Mnt Fwd Ctr	42
S	1601-001	A/C COMPRESSOR	A/C Compressor Large Capacity	42
S	1530-100	UNDER CAB INSULATION	Under Cab Insulation Engine Tunnel	42

CAB INTERIOR

S	1327-001	INTERIOR TRIM FLOOR	Interior Trim Floor	42
S	1302-001	INTERIOR TRIM	Interior Trim Vinyl	42
S	1368-002	REAR WALL INTERIOR TRIM	Rear Wall Interior Trim Vinyl	42
S	1306-006	HEADER TRIM	Header Trim XDuty	43
S	1305-014	TRIM CENTER DASH	Trim Center Dash XDuty	43

S	1339-102	TRIM LEFT HAND DASH	Trim LH Dash XDuty	43
S	1321-004	TRIM RIGHT HAND DASH	Trim RH Dash XDuty Glove Cmpt/MDT Prov	43
S	1307-002	ENGINE TUNNEL TRIM	Eng Tnl Trim Flr Mat	43
O	5040-188	POWER POINT DASH MOUNT	Pwr Pnt Dash Mnt Batt Dir (1) Sw Pnl/(1) Dual USB Blue Sea 4.8A Batt Dir Sw Pnl	43
S	1303-017	STEP TRIM	Step Trim Grip Strut Lwr Flex-Tred Mid	43
O	1379-002	UNDER CAB ACCESS DOOR	Under Cab Access Door Rear Step LH DA Sanded	44
S	1102-013	INTERIOR DOOR TRIM	Interior Door Trim Painted	44
O	1105-001	CAB DOOR TRIM REFLECTIVE	Cab Dr Trim Reflective Vert Stripe/6" Chevron w/Logo	44
S	1308-001	INTERIOR GRAB HANDLE "A" PILLAR	Interior Grab Handle 'A' Pillar 11" Molded	44
S	1332-008	INTERIOR GRAB HANDLE FRONT DOOR	Interior Grab Handle Frt Door Horiz 9"	44
S	1345-002	INTERIOR GRAB HANDLE REAR DOOR	Int Grab Handle Rr Dr Alum Window Span 30" Black Powder Coat	44
S	1301-003	INTERIOR SOFT TRIM COLOR	Interior Soft Trim Color Gray	44
S	1337-001	INTERIOR TRIM SUNVISOR	Interior Trim Sunvisor Vinyl	44
S	1304-001	INTERIOR FLOOR MAT COLOR	Interior Floor Mat Color Gray	45
S	1335-017	CAB PAINT INTERIOR DOOR TRIM	Cab Paint Int Dr Trim Multi-tone Silver Gray	45
S	1371-017	HEADER TRIM INTERIOR PAINT	Header Trim Interior Paint Multi-tone Silver Gray	45
S	1370-019	TRIM CENTER DASH INTERIOR PAINT	Trim Center Dash Interior Paint Multi-tone Silver Gray	45
S	1378-018	TRIM LEFT HAND DASH INTERIOR PAINT	Trim LH Dash Interior Paint Multi-tone Silver Gray	45
S	1373-018	TRIM RIGHT HAND DASH INTERIOR PAINT	Trim RH Dash Interior Paint Multi-tone Silver Gray	45
S	1344-002	DASH PANEL GROUP	Dash Pnl Group 3-Pnl	45
O	1312-005	SWITCHES CENTER PANEL	Switches Ctr Pnl 12 Upr	45
S	1313-004	SWITCHES LEFT PANEL	Switches Left Pnl 8 (6+2) w/Headlight/Dimmer/Wiper	45
S	1314-001	SWITCHES RIGHT PANEL	Switches Right Pnl 0	46

CAB SEATS

S	1225-018	SEAT BELT WARNING	Seat Belt Warn Indv Seat Loc & LED Display w/VDR Weldon	46
S	1237-005	SEAT MATERIAL	Seat Material Bostrom Durawear Plus	46
S	1243-001	SEAT COLOR	Seat Color Gray/Red Seat Belts	46
S	1249-001	SEAT BACK LOGO	Seat Back Logo Spartan	46
O	1201-007	SEAT DRIVER	Seat Driver Bostrom Firefighter 8-Way Elect ABTS	46
S	1213-025	SEAT BACK DRIVER	Seat Back Driver Non-SCBA ABTS	47
S	1219-001	SEAT MOUNTING DRIVER	Seat Mounting Driver	47
O	1202-048	SEAT OFFICER	Seat Officer Bostrom Firefighter 2-Way Manual 300 Series ABTS	47
S	1214-028	SEAT BACK OFFICER	Seat Back Officer Non-SCBA ABTS	47
S	1220-002	SEAT MOUNTING OFFICER	Seat Mounting Officer	48
O	1297-002	POWER SEAT WIRING	Power Seats Wiring Battery Direct	48
S	1273-001	SEAT BELT ORIENTATION CREW	Seat Belt Orientation Crew Outboard Shoulder To Inboard Hip	48
S	1263-001	SEAT REAR FACING OUTER LOCATION	Seat RFO Location (2) R/L	48

O	1203-029	SEAT CREW REAR FACING OUTER	Seat Crew RFO Bostrom Firefighter Flip-Up 300 Series	48
O	1215-027	SEAT BACK REAR FACING OUTER	Seat Back RFO SCBA Bostrom SecureAll w/Quick-Adjust	48
S	1221-009	SEAT MOUNTING REAR FACING OUTER	Seat Mounting RFO Rwd 2"	49
O	1266-001	SEAT FORWARD FACING CENTER LOCATION	Seat FFC Location (2) Ctr	49
O	1206-041	SEAT CREW FORWARD FACING CENTER	Seat Crew FFC Bostrom Firefighter Flip-Up 300 Series	49
O	1218-031	SEAT BACK FORWARD FACING CENTER	Seat Back FFC SCBA Bostrom SecureAll w/Quick-Adjust	50
O	1269-101	SEAT FRAME FORWARD FACING	Seat Frm Fwd Fcg Dual	50
O	1281-104	SEAT FRAME FORWARD FACING STORAGE ACCESS	Seat Frm Fwd Fcg Strg Acc Cutout (2) R/L Sd	50
O	1224-002	SEAT MOUNTING FORWARD FACING CENTER	Seat Mounting Forward Facing Center	50

CAB EXTERIOR

S	1511-200	WINDSHIELD WIPER SYSTEM	Windshield Wiper System	50
S	1534-002	ELECTRONIC WINDSHIELD FLUID LEVEL INDICATOR	Electronic Windshield Fluid Level Indicator	51
S	1103-002	CAB DOOR HARDWARE	Cab Door Hardware Black Composite	51
O	1111-004	DOOR LOCKS	Door Locks Power (4) Entry Doors	51
O	1112-004	POWER DOOR LOCK COMPARTMENT ACTIVATION	Power Door Lock Cmpt Actv Key Fob & Keypads	51
S	1503-200	GRAB HANDLES	Grab Handles SS 18"	51
O	1504-014	REARVIEW MIRRORS	Mirror Aerodynamic Retractable 613305 Rmt Htd	52
O	1529-002	REARVIEW MIRROR HEAT SWITCH	Rearview Mirror Heat Sw Pnl	52
S	1513-002	CAB FENDER	Cab Fender Alum w/ABS Liner	52
S	1526-005	CAB EXTERIOR FRONT & SIDE EMBLEMS	Cab Ext Frt & Side Emblems Spartan Frt Only	52

START / CHARGING SYSTEMS

S	5109-001	IGNITION	Ign Mstr Sw w/Keyless Start	52
S	5101-020	BATTERY	Batt (3) Group 31 Harris	53
S	5106-001	BATTERY TRAY	Batt Tray LH Steel	53
S	5107-002	BATTERY BOX COVER	Batt Box Cover LH Steel w/Black Handle	53
S	5102-002	BATTERY CABLE	Batt Cables w/Rmt Terminal Stud	53
O	5108-010	BATTERY JUMPER STUD	Batt Jumper Stud Frt LH Lwr Step 8" Apart	53
O	5104-002	ALTERNATOR	Alternator Leece-Neville 320A	53
S	5105-001	STARTER MOTOR	Starter Motor Delco	53

LINE VOLTAGE ELECTRICAL POWER DISTRIBUTION

O	5202-075	BATTERY CONDITIONER	Batt Cond Kussmaul Auto Charge 40 LPC LH RFO Seat Position	53
O	5203-002	BATTERY CONDITIONER DISPLAY	Batt Cond Display LH Mid Glass	54
O	5209-002	ELECTRICAL INLET LOCATION	Elec Inlet Location LH Cab Side Mid	54
O	5204-055	ELECTRICAL INLET	Elec Inlet 120V 20A Auto Eject	54
O	5210-004	ELECTRICAL INLET CONNECTION	Elec Inlet Conn to Batt Conditioner	54

O	5206-002	ELECTRICAL INLET COLOR	Elec Inlet Color Yellow	54
---	----------	-------------------------------	-------------------------	----

LIGHTING

O	5301-102	HEADLIGHTS	Headlights 4 Headlamps LED	54
S	5303-004	FRONT TURN SIGNALS	Frnt Turn Signals Whelen 600 LED	54
S	5337-001	HEADLIGHT LOCATION	Headlights Below Frt Warn Lts	55
S	5336-015	SIDE TURN/MARKER LIGHTS	Side Turn/Marker Lts LED Tecniq S170	55
O	5302-018	MARKER & ICC LIGHTS	Marker & ICC Lts Face Mnt LED In Scene Lt	55
S	5350-092	HEADLIGHT AND MARKER LIGHT ACTIVATION	Hdlt & Mrkr Lt Actv Rkr Sw/DRL Ign Sw	55
O	5426-002	LIGHTBAR SWITCH	Lightbar Sw Pnl	55
S	5305-350	INTERIOR OVERHEAD LIGHTS	Interior Overhead Lts Red/Clear LED	55
S	5388-002	INTERIOR OVERHEAD LIGHTING ACTIVATION	Int Ovrhd Lt Actv Resp Dr	55
O	5403-062	LIGHTBAR PROVISION	Lightbar Prov Wire & Lwr Mnt Chassis Supply	55
O	5450-232	CAB FRONT LIGHTBAR	Cab Frnt Ltbar Whelen Freedom F4N72QLED 6R2C Layout 1	55
O	5317-158	FRONT SCENE LIGHTS	Frnt Scene Lts FireTech FT-B-72-ML-W 12V LED 72" White	56
O	5329-003	FRONT SCENE LIGHT LOCATION	Frnt Scene Lt Loc Ctr Brow Pos	56
O	5335-041	FRONT SCENE LIGHTS ACTIVATION	Frnt Scene Lts Actv Rkr Sw Pnl (3) Sw Indv Circuit Scene/Spot/Flood Brow Lt	56
O	5306-065	SIDE SCENE LIGHTS	Side Scene Lts Whelen 900 12V Super 24 LED Clear Gradient	56
O	5318-004	SIDE SCENE LIGHT LOCATION	Side Scene Lt Loc Upper Mid Rwd 10" Roof Position	56
O	5316-004	SIDE SCENE ACTIVATION	Side Scene Actv Indv Sw & Resp Side Doors	56
S	5308-300	GROUND LIGHTS	Ground Lts Tecniq T44 LED	56
S	5386-002	GROUND LIGHTING ACTIVATION	Ground Lt Actv Prk Brk	56
S	5309-003	LOWER CAB STEP LIGHTS	Lwr Cab Step Lts Tecniq T44 LED	57
S	5382-008	INTERMEDIATE STEP LIGHTS	Intermediate Step Lts Tecniq D06 LED Frt Drs	57
S	5312-003	ENGINE COMPARTMENT LIGHT	Engine Cmpt Work Lt LED (1)	57

OPTICAL WARNING DEVICES

S	5406-119	DO NOT MOVE APPARATUS LIGHT	Do Not Move App Lt Flashing Red Tecniq K50 LED w/Alarm	57
S	5422-001	MASTER WARNING SWITCH	Mstr Warn Sw Pnl	57
O	5401-002	INBOARD FRONT WARNING LIGHTS	Inboard Frnt Warn Lts Whelen 600 LED Chrm Bezel	57
O	5413-002	INBOARD FRONT WARNING LIGHTS COLOR	Inboard Frnt Warn Lts Color Red	57
O	5423-007	FRONT WARNING SWITCH	Frnt Warn Sw Pnl	58
O	5404-002	INTERSECTION WARNING LIGHTS	Intersection Warn Lts Whelen 600 Super LED	58
O	5419-002	INTERSECTION WARNING LIGHTS COLOR	Int Warn Lts Color Red	58
O	5420-002	INTERSECTION WARNING LIGHTS LOCATION	Intersection Warn Lts Location Bumper Tail Rwd	58
O	5424-008	SIDE AND INTERSECTION WARNING SWITCH	Side & Intersection Warn Sw Pnl	58

AUDIBLE WARNING DEVICES

O	5510-004	SIREN CONTROL HEAD	Siren Ctrl Head Whelen 295HFS2	58
---	----------	---------------------------	--------------------------------	----

O	5526-003	AUDIBLE WARNING LH FOOT SWITCH	Audible Warning LH Foot Switch Air Horn & Siren	58
O	5526A-001	AIR HORN FOOT SWITCH LH	Air Horn Foot Switch LH Linemaster 491-S	58
O	5526B-001	AIR HORN FOOT SWITCH LH LOCATION	Air Horn Foot Switch LH Location A-Pillar	58
O	5526C-001	AIR HORN FOOT SWITCH LH POSITION	Air Horn Foot Switch LH Position Inboard of Other Foot Switch	59
O	5526D-001	MECHANICAL SIREN FOOT SWITCH LH	Mechanical Siren Foot Switch LH Linemaster 491-S	59
O	5526E-001	MECHANICAL SIREN FOOT SWITCH LH LOCATION	Mechanical Foot Switch LH Location A-Pillar	59
O	5526F-001	MECHANICAL SIREN FOOT SWITCH LH POSITION	Mechanical Siren Foot Switch Position Outboard of Other Foot Switches	59
O	5529-002	AUDIBLE WARNING LH FOOT SWITCH BRACKET	Audible Warn LH Ft Sw Double Brkt 30Deg TPlate	59
O	5512-042	AIR HORN AUXILIARY ACTIVATION	Air Horn Actv PB Sw Pnl	59
O	5513-090	MECHANICAL SIREN BRAKE/AUXILIARY ACTIVATION	Mech Siren Actv PB Sw Pnl/PB Brk Sw	59
O	5532-001	MECHANICAL SIREN INTERLOCK	Mechanical Siren Interlock Master Warn Only	59
S	5505-002	BACK-UP ALARM	Back-Up Alarm Ecco 575	59

INSTRUMENTATION

S	5601-041	INSTRUMENTATION	Instrumentation Standard	59
S	5624-001	BACKLIGHTING COLOR	Backlighting Color Red	62

COMMUNICATIONS SYSTEMS

O	5728-009	CAMERA REAR	Camera HD Rear Box	62
O	5731-012	CAMERA DISPLAY	Camera Display LH HD Monitor	62
O	5703-010	COMMUNICATION ANTENNA	Comm Ant Base RH Fwd Cab Rf Chassis Sply	62
O	5708-003	COMMUNICATION ANTENNA CABLE ROUTING	Comm Ant Cable Routing Under Rkr Sw Pnl	62
O	5709-007	AUXILIARY COMMUNICATION ANTENNA	Aux Comm Ant Base RH Inboard Fwd Cab Roof Chassis Sply	62
O	5710-003	AUXILIARY COMMUNICATION ANTENNA CABLE ROUTING	Aux Comm Ant Cable Routing Under Rkr Sw Pnl	62
S	5020-001	PANEL LAYOUT	Panel Layout	

ADDITIONAL EQUIPMENT

S	8814-002	CAB EXTERIOR PROTECTION	Cab Exterior Protection Front	62
S	8806-001	FIRE EXTINGUISHER	Fire Extinguisher Shiploose	63
S	8810-001	DOOR KEYS	Door Keys for Manual Locks (4)	63

SALES ADMIN

S	8003-200	WARRANTY	Warranty Cab and Chassis (1) Year RFW0101	63
S	8030-006	CHASSIS OPERATION MANUAL	Chassis Operation Manual Digital Copy (2)	63
S	8031-024	ENGINE & TRANSMISSION OPERATION MANUAL	Eng & Trans Operation Man Eng Hard Copy/Trans Digital/Eng Owner Digital	63

S	8805-007	CAB/CHASSIS AS BUILT WIRING DIAGRAMS	Cab/Chassis As Built Wiring Diagrams Digital Copy (2)	63
S	8039-001	SALES TERMS	Sales Terms	63

ENGINEERING

O	9005-002	DRIVELINE LAYOUT CONFIRMATION	Driveline Layout Confirmation Required	63
O	2124-009	EFCM/REAR CROSSMEMBERS	End of Frame Cross Member 2.25" From EOF	

Specification

MODEL

The chassis shall be an FC-94 model. The cab and chassis shall include design considerations for multiple emergency vehicle applications, rapid transit and maneuverability. The chassis shall be manufactured for heavy duty service with the strength and capacity to support a fully laden apparatus, one hundred (100) percent of the time.

MODEL YEAR

The chassis shall have a vehicle identification number that reflects a 2024 model year.

COUNTRY OF SERVICE

The chassis shall be put in service in the country of United States of America (USA).

The chassis will meet applicable U.S.A. federal motor vehicle safety standards per CFR Title 49 Chapter V Part 571 as clarified in the incomplete vehicle book per CFR Title 49 Chapter V Part 568 Section 4 which accompanies each chassis. The chassis manufacturer is not responsible for compliance to state, regional, or local regulations. Dealers should identify those regulations and order any necessary optional equipment from the chassis manufacturer or their OEM needed to be in compliance with those regulations.

CAB AND CHASSIS LABELING LANGUAGE

The cab and chassis shall include the applicable caution, warning, and safety notice labels with text to be written in English.

APPARATUS TYPE

The apparatus shall be a pumper vehicle designed for emergency service use which shall be equipped with a permanently mounted fire pump which has a minimum rated capacity of 750 gallons per minute (3000 L/min). The apparatus shall include a water tank and hose body whose primary purpose is to combat structural and associated fires.

VEHICLE TYPE

The chassis shall be manufactured for use as a straight truck type vehicle and designed for the installation of a permanently mounted apparatus behind the cab. The apparatus of the vehicle shall be supplied and installed by the apparatus manufacturer.

VEHICLE ANGLE OF APPROACH PACKAGE

The angle of approach of the apparatus shall be a minimum of 8.00 degrees.

NFPA1901 Angle of Approach definition:

“To determine the angle of approach, place a thin steel strip against the front of the tires where they touch the ground or stretch a tight string from one front tire to the other at the front where they touch the ground. Determine the lowest point (component or equipment) on the vehicle forward of the front tire that would make the smallest angle of approach. Hang a plumb bob from the lowest point and mark the point on the ground where the point of the plumb bob touches. Measure the vertical distance from the ground to the point where the plumb bob was hung (distance V). Measure the horizontal distance from the plumb bob point to the steel strip or string running from front tire to front tire (distance H). Divide the vertical distance by the horizontal distance. The ratio of V/H is the tangent of the angle of approach. If the ratio is known, the angle of approach can be determined from a table of trigonometric functions of angles or from a math calculator. The standard requires a minimum angle of approach of 8.00 degrees: since the tangent of 8.00 degrees is 0.1405, if V divided by H is 0.1405 or larger, the angle of approach is 8.00 degrees or greater.”

AXLE CONFIGURATION

The chassis shall feature a 4 x 2 axle configuration consisting of a single rear drive axle with a single front steer axle.

GROSS AXLE WEIGHT RATINGS FRONT

The front gross axle weight rating (GAWR) of the chassis shall be 21,500 pounds.

This front gross axle weight rating shall be adequate to carry the weight of the completed apparatus including all equipment and personnel.

GROSS AXLE WEIGHT RATINGS REAR

The rear gross axle weight rating (GAWR) of the chassis shall be 31,500 pounds.

This rear gross axle weight rating shall be adequate to carry the weight of the completed apparatus including all equipment and personnel.

PUMP PROVISION

The chassis shall include provisions to mount a drive line pump in the middle of the chassis, behind the cab, more commonly known as the midship location. Chassis driveline pump provisions shall include an interlock feature for automatic setting of the park brake when the vehicle is shifted into pump mode while the transmission is in neutral and the transmission output speed translates to less than 1 mph. When the conditions are met the driver side parking brake valve shall activate. Once shifted to road mode the condition for electric automatic brake engagement is no longer present and the driver's parking brake control valve shall function normally.

WATER & FOAM TANK CAPACITY

The chassis shall include a carrying capacity of 750 gallons (2839 liters) to 1250 gallons (4732 liters). The water and/or foam tank(s) shall be supplied and installed by the apparatus manufacturer.

CAB STYLE

The cab shall be a custom, fully enclosed, MFD model with a 10.00 inch raised roof over the driver, officer, and crew area, designed and built specifically for use as an emergency response vehicle by a company specializing in cab and chassis design for all emergency response applications. The cab shall be designed for heavy-duty service utilizing superior strength and capacity for the application of protecting the occupants of the vehicle. This style of cab shall offer up to eight (8) seating positions.

The cab shall incorporate a fully enclosed design with side wall roof supports, allowing for a spacious cab area with no partition between the front and rear sections of the cab. To provide a superior finish by reducing welds that fatigue cab metal; the roof, the rear wall and side wall panels shall be assembled using a combination of welds and proven industrial adhesives designed specifically for aluminum fabrication for construction.

The cab shall be constructed using multiple aluminum extrusions in conjunction with aluminum plate, which shall provide proven strength and the truest, flattest body surfaces ensuring less expensive paint repairs if needed. All aluminum welding shall be completed to the American Welding Society and ANSI D1.2-96 requirements for structural welding of aluminum.

All interior and exterior seams shall be sealed for optimum noise reduction and to provide the most favorable efficiency for heating and cooling retention.

The cab shall be constructed of 5052-H32 corrosion resistant aluminum plate. The cab shall incorporate tongue and groove fitted 6061-T6 0.13 & 0.19 inch thick aluminum extrusions for extreme duty situations. A single formed, one (1) piece extrusion shall be used for the "A" pillar, adding strength and rigidity to the cab as well as additional roll-over protection. The cab side walls and lower roof skin shall be 0.13 inch thick; the rear wall and raised roof skins shall be 0.09 inch thick; the front cab structure shall be 0.19 inch thick.

The exterior width of the cab shall be 94.00 inches wide with a minimum interior width of 88.00 inches. The overall cab length shall be 131.10 inches with 54.00 inches from the centerline of the front of the axle to the back of the cab.

The cab interior shall be designed to afford the maximum usable interior space and attention to ergonomics with hip and legroom while seated which exceeds industry standards. The crew cab floor shall be flat across the entire walking area for ease of movement inside the cab.

The cab shall offer an interior height of 57.50 inches from the front floor to the headliner in the non-raised roof area and a rear floor to headliner height of 65.00 inches in the raised roof area, at a minimum. The cab shall offer an interior measurement at the floor level from the rear of the engine tunnel to the rear wall of the cab of 51.88 inches. All interior measurements shall include the area within the interior trimmed surfaces and not to any unfinished surface.

The cab shall include a driver and officer area with two (2) cab doors large enough for personnel in full firefighting gear. The front doors shall offer a clear opening of 40.25 inches wide X 53.50 inches high, from the cab floor to the top of the door opening. The cab shall also include a crew area with up to two (2) cab doors, also large enough for personnel in full firefighting gear. The rear doors shall offer a clear opening of 32.25 inches wide X 61.00 inches high, from the cab floor to the top of the door opening.

The cab shall incorporate a progressive two (2) step configuration from the ground to the cab floor at each door opening. The progressive steps are vertically staggered and extend the full width of each step well allowing personnel in full firefighting gear to enter and exit the cab easily and safely.

The first step for the driver and officer area shall measure approximately 11.50 inches deep X 31.13 inches wide. The intermediate step shall measure approximately 8.50 inches deep X 32.50 inches wide. The height from the first step to the intermediate step and the intermediate step to the cab floor shall not exceed 11.00 inches.

The first step for the crew area shall measure approximately 11.50 inches deep X 20.44 inches wide. The intermediate step shall measure approximately 10.25 inches deep X 22.75 inches wide. The height from the first step to the intermediate step and the intermediate step to the cab floor shall not exceed 12.80 inches.

CAB FRONT FASCIA

The front cab fascia shall be constructed of 5052-H32 Marine Grade, 0.13 of an inch thick plate which shall be an integral part of the cab.

The cab fascia will encompass the entire front of the aluminum cab structure from the bottom of the windshield to the bottom of the cab and shall be the “Classic” design.

The front cab fascia shall include two (2) modules on each side accommodating a total of up to four (4) Hi/Low beam headlights and two (2) turn signal lights or up to four (4) warning lights. Two (2) chrome plated bezels shall be provided on each side around each set of two lamps.

FRONT GRILLE

The front fascia shall include a 304 stainless steel front grille.

CAB UNDERCOAT

There shall be a rubberized undercoating applied to the underside of the cab that provides abrasion protection, sound deadening and corrosion protection.

CAB SIDE DRIP RAIL

There shall be a drip rail along the top radius of each cab side. The drip rails shall help prevent water from the cab roof running down the cab side.

CAB PAINT EXTERIOR

The cab exterior shall be painted a single color per customers specified paint color.

CAB PAINT PROCESS/MANUFACTURER

The cab shall be painted with PPG Industries paint prior to the installation of glass accessories and all other cab trim to ensure complete paint coverage and the maximum in corrosion protection of all metal surfaces.

All metal surfaces on the cab shall be mechanically etched by sanding disc to remove any surface oxidation or surface debris which may hinder the paint adhesion. Once all imperfections on the exterior surfaces are removed and sanded smooth, body fillers shall be applied to the cab on all surfaces that require a critically aesthetic finish and sanded smooth.

The entire cab shall then be coated with a high quality base primer that is designed to fill any minor surface defects, provide an adhesive bond between the primer and the paint and improve the color and gloss retention of the color. The finish to this procedure shall be sanding the cab to a smooth finish followed by sealing the seams with an automotive seam sealer. The minimum thickness of the primer coat after sanding shall be 2.50 mils with a maximum thickness of 5.00 mils.

The cab shall then be painted the specific color(s) designated by the customer with an acrylic urethane type system designed to retain color and resist acid rain and most atmospheric chemicals found on an emergency scene. The paint shall have a minimum thickness of 1.00 mils with a maximum of 4 mils, followed by a clear top coat with a minimum of 2.5 mils and a maximum of 3.5 mils. The entire cab shall then be baked to speed the curing process of the coatings.

CAB PAINT PRIMARY/LOWER COLOR

The primary/lower paint color shall be PPG FBCH 2185 White.

CAB PAINT WARRANTY

Purchaser shall receive a Paint and Finish (Exterior Clear coated) One (1) Year limited warranty in accordance with, and subject to, warranty certificate RFW0701. The warranty certificate is incorporated by reference into this proposal, and included with this proposal or available upon request.

CAB PAINT INTERIOR

The visible interior cab structure surfaces shall be painted with a multi-tone silver gray texture finish.

CAB ENTRY DOORS

The cab shall include four (4) entry doors, two (2) front doors and two (2) crew doors designed for ease of entering and egress when outfitted with an SCBA. The doors shall be constructed of extruded aluminum with a nominal thickness of 0.13 inch. The exterior skins shall be constructed of 0.13 inch aluminum plate.

The doors shall include a double rolled style automotive rubber seal around the perimeter of each door frame and door edge which ensures a weather tight fit.

All door hinges shall be hidden within flush mounted cab doors for a pleasing smooth appearance and perfect fit along each side of the cab. Each door hinge shall be piano style with a 0.38 inch pin and shall be constructed of stainless steel.

CAB ENTRY DOOR TYPE

All cab entry doors shall be barrier clear design resulting in exposed lower cab steps. The doors shall provide approximately 32.00 inches of clearance from the ground to the bottom of the door so cab doors may be opened un-hindered by most obstacles encountered, such as guard rails along interstate highways.

Entry doors shall include Pollak mechanical plunger style switches for electrical component activation.

CAB INSULATION

The cab ceiling and walls shall include a nonwoven polyester fiber insulation. The insulation shall act as a barrier absorbing noise as well as assisting in sustaining the desired climate within the cab interior.

CAB STRUCTURAL WARRANTY

Purchaser shall receive a Cab Structure (Aluminum) Five (5) Years limited warranty in accordance with, and subject to, warranty certificate RFW0601. The warranty certificate is incorporated by reference into this proposal, and included with this proposal or available upon request.

CAB TEST INFORMATION

The cab shall have successfully completed the preload side impact, static roof load application and frontal impact without encroachment to the occupant survival space when tested in accordance with Section 4 of SAE J2420 COE Frontal Strength Evaluation Dynamic Loading Heavy Trucks, Section 5 of SAE J2422 Cab Roof Strength Evaluation Quasi –Static Loading Heavy Trucks and ECE R29 Uniform Provisions Concerning the Approval of Vehicles with regard to the Protection of the Occupants of the Cab of a Commercial Vehicles Annex 3 Paragraph 5.

The above tests have been witnessed by and attested to by an independent third party. The test results were recorded using cameras, high speed imagers, accelerometers and strain gauges. Documentation of the testing shall be provided upon request.

ELECTRICAL SYSTEM

The chassis shall include a single starting electrical system which shall include a 12 volt direct current multiplexing system, suppressed per SAE J551. The wiring shall be appropriate gauge cross link with 311 degree Fahrenheit insulation. All SAE wires in the chassis shall be color coded and shall include the circuit number and function where possible. The wiring shall be protected by 275 degree Fahrenheit minimum high temperature flame retardant loom. All nodes and sealed Deutsch connectors shall be waterproof.

DATA RECORDING SYSTEM

The chassis shall have a Weldon Vehicle Data Recorder (VDR) system installed. The system shall be designed to meet NFPA 1901 and shall be integrated with the Weldon Multiplex electrical system. The following information shall be recorded:

- Vehicle Speed
- Acceleration
- Deceleration

- Engine Speed
- Engine Throttle Position
- ABS Event
- Seat Occupied Status
- Seat Belt Status
- Master Optical Warning Device Switch Position
- Time
- Date

Each portion of the data shall be recorded at the specified intervals and stored for the specified length of time to meet NFPA 1901 guidelines and shall be retrievable by connecting a laptop computer to the VDR system. The laptop connection shall be a panel mounted female type B USB connection point, remotely mounted in the left side foot well.

LOAD MANAGEMENT SYSTEM

The apparatus load management shall be performed by the included multiplex system. The multiplex system shall also feature the priority of sequences and shall shed electrical loads based on the priority list specifically programmed.

ACCESSORY POWER

The electrical distribution panel shall include two (2) power studs. The studs shall be size #10 and each of the power studs shall be circuit protected with a fuse of the specified amperage. One (1) power stud shall be capable of carrying up to a 40 amp battery direct load. One (1) power stud shall be capable of carrying up to a 15 amp ignition switched load. The two (2) power studs shall share one (1) #10 ground stud. A 225 amp battery direct power and ground stud shall be provided and installed on the chassis near the left hand battery box for OEM body connections.

EXTERIOR ELECTRICAL TERMINAL COATING

All terminals exposed to the elements will be sprayed with a high visibility protective rubberized coating to prevent corrosion.

ELECTRICAL SYSTEM WARRANTY

Purchaser shall receive an Electrical System One (1) Year or 18,000 Miles limited warranty in accordance with, and subject to, warranty certificate RFW0201. The warranty certificate is incorporated by reference into this proposal, and included with this proposal or available upon request.

ENGINE

The chassis engine shall be a Cummins L9 engine. The L9 engine shall be an in-line six (6) cylinder, four cycle diesel powered engine. The engine shall offer a rating of 450 horse power at 2100 RPM and shall be governed at 2200 RPM. The torque rating shall feature 1250 foot pounds of torque at 1200 RPM with 543 cubic inches (8.9 liters) of displacement.

The L9 engine shall feature a VGT™ Turbocharger, a high pressure common rail fuel system, fully integrated electronic controls with an electronic governor, and shall be EPA certified to meet the 2021 emissions standards using cooled exhaust gas recirculation and selective catalytic reduction technology.

The engine shall include an engine mounted combination full flow/by-pass oil filter with replaceable spin on cartridge for use with the engine lubrication system. The engine shall include Citgo brand Citgard 500, or equivalent SAE 15W40 CK-4 low ash engine oil which shall be utilized for proper engine lubrication.

A wiring harness shall be supplied ending at the back of the cab. The harness shall include a connector which shall allow an optional harness for the pump panel. The included circuits shall be provided for a tachometer, oil pressure, engine temperature, hand throttle, high idle and a PSG system. A circuit for J1939 data link shall also be provided at the back of the cab.

CAB ENGINE TUNNEL

The cab interior shall include an integrated engine tunnel constructed of 5052-H32 Marine Grade, 0.19 of an inch thick aluminum. The tunnel shall be a maximum of 41.50 inches wide X 25.50 inches high.

DIESEL PARTICULATE FILTER CONTROLS

There shall be two (2) controls for the diesel particulate filter. One (1) control shall be for regeneration and one (1) control shall be for regeneration inhibit.

ENGINE PROGRAMMING HIGH IDLE SPEED

The engine high idle control shall maintain the engine idle at approximately 1250 RPM when engaged.

ENGINE HIGH IDLE CONTROL

The vehicle shall be equipped with a high-idle speed rocker switch and an automatic high-idle speed control. It shall be pre-set so when activated, it will operate the engine at the appropriate RPM to increase alternator output. This device shall operate only when the engine is running and the transmission is in neutral with the parking brake set. When automatically engaged the high idle shall disengage when the operator depresses the brake pedal, or the transmission is placed in gear, and shall be available to manually or automatically re-engage when the brake is released, or when the transmission is placed in neutral.

ENGINE PROGRAMMING ROAD SPEED GOVERNOR

The engine shall include programming which will govern the top speed of the vehicle.

AUXILIARY ENGINE BRAKE

A compression brake, for the six (6) cylinder engine shall be provided. A cutout relay shall be installed to disable the compression brake when in pump mode or when an ABS event occurs. The engine compression brake shall activate upon 0% accelerator when in operation mode and actuate the vehicle's brake lights.

The engine shall utilize a variable geometry turbo (VGT) as an integrated auxiliary engine brake to offer a variable rate of exhaust flow, which when activated in conjunction with the compression brake shall enhance the engine's compression braking capabilities.

AUXILIARY ENGINE BRAKE CONTROL

An engine compression brake control device shall be included. The electronic control device shall monitor various conditions and shall activate the engine brake only if all of the following conditions are simultaneously detected:

- A valid gear ratio is detected.
- The driver has requested or enabled engine compression brake operation.
- The throttle is at a minimum engine speed position.
- The electronic controller is not presently attempting to execute an electronically controlled final drive gear shift.

The compression brake shall be controlled through an on/off switch and a low/medium/high selector switch.

ELECTRONIC ENGINE OIL LEVEL INDICATOR

The engine oil shall be monitored electronically and shall send a signal to activate a warning in the instrument panel when levels fall below normal. The warning shall activate in a low oil situation upon turning on the master battery and ignition switches without the engine running.

FLUID FILLS

The engine oil, coolant, transmission, and power steering fluid fills shall be located under the cab. The windshield washer fill shall be accessible through the front left side mid step.

ENGINE DRAIN PLUG

The engine shall include an original equipment manufacturer installed oil drain plug.

ENGINE WARRANTY

The Cummins engine shall be warranted for a period of five (5) years or 100,000 miles, whichever occurs first.

REMOTE THROTTLE HARNESS

An apparatus interface wiring harness for the engine and transmission pump interlocks shall be supplied with the chassis. The harness shall include a connector for connection to a chassis pump panel harness supplied by the body builder and shall terminate in the left frame rail behind the cab for connection by the body builder. The harness shall include circuits deemed for a pump panel and shall contain circuits for a hand throttle, and a multiplexed gauge. Separate circuits shall also be included for a pump control switch, "Pump Engaged" and "OK to Pump" indicator lights, open compartment ground, start signal, park brake ground, ignition signal, master power, clean power, customer ignition, air horn solenoid switch, high idle switch and high idle indicator light. The harness shall contain interlocks that will

prevent shifting to road or pump mode unless the transmission output speed translates to less than 1 mph and the transmission is in neutral. The shift to pump mode shall also require the park brake be set.

ENGINE PROGRAMMING REMOTE THROTTLE

The engine ECM (Electronic Control Module) discreet wire remote throttle circuit shall be turned off for use with a J1939 based pump controller or when the discreet wire remote throttle controls are not required.

ENGINE PROGRAMMING IDLE SPEED

The engine low idle speed will be programmed at 700 rpm.

ENGINE AIR INTAKE

The engine air intake system shall include an ember separator. This ember separator shall be designed to protect the downstream air filter from embers using a combination of unique flat and crimped metal screens packaged in a heavy duty galvanized steel frame. This multilayered screen shall trap embers and allow them to burn out before passing through the pack.

The engine air intake system shall also include an air cleaner mounted above the radiator. This air cleaner shall utilize a replaceable dry type filter element designed to prevent dust and debris from being ingested into the engine. A service cover shall be provided on the housing, reducing the chance of contaminating the air intake system during air filter service.

The air intake system shall include a restriction indicator light in the warning light cluster on the instrument panel, which shall activate when the air cleaner element requires replacement.

ENGINE FAN DRIVE

The engine cooling system fan shall incorporate a thermostatically controlled, Horton fully variable type fan drive with SmartClutch J-1939 CAN controller. The clutch fan shall override the thermostatic variable speed and function as full on automatically in pump mode.

The variable speed fan clutch only engages at the amount needed for proper cooling to facilitate improved vehicle performance, cab heating in cold climates, and fuel economy. The fan clutch design shall be fail-safe so that if the clutch drive fails the fan shall engage to prevent engine overheating due to the fan clutch failure. The fan speed shall include a J-1939 CAN clutch controller to receive signal from the engine control module to activate at variable rates of speed. Variable speeds shall be set through thermostatic and engine speed signals to run as efficiently and quietly as required to maintain temperature.

ENGINE COOLING SYSTEM

There shall be a heavy-duty aluminum cooling system designed to meet the demands of the emergency response industry. The cooling system shall have the capacity to keep the engine properly cooled under all conditions of road and pumping operations. The cooling system shall be designed and tested to meet or exceed the requirements specified by the engine and transmission manufacturer and all EPA requirements. The complete cooling system shall be mounted to isolate the entire system from vibration

or stress. The individual cores of the cooling system shall be mounted in a manner to allow expansion and contraction at various rates without inducing stress into the adjoining cores.

The cooling system shall be comprised of a charge air cooler to radiator serial flow package that provides the maximum cooling capacity for the specified engine as well as serviceability. The main components shall include a surge tank, a charge air cooler bolted to the front of the radiator, recirculation shields, a shroud, a fan, and required tubing.

The radiator shall be a down-flow design constructed with aluminum cores, plastic end tanks, and a steel frame. The radiator shall be equipped with a drain cock to drain the coolant for serviceability.

The cooling system shall include a one piece injected molded polymer fan with a three (3) piece fiberglass fan shroud.

The cooling system shall be equipped with a surge tank that is capable of removing entrained air from the system. The surge tank shall be equipped with a low coolant probe and rearward oriented sight glass to observe coolant in the system. A cold fill and observation line shall be included within the frame mounted translucent recovery bottle to monitor the level of the coolant. The surge tank shall have a dual seal cap that meets the engine manufacturer's pressure requirements and allows for expansion and recovery of coolant into a separate integral expansion chamber.

All radiator tubes shall be formed from aluminized steel tubing. Recirculation shields shall be installed where required to prevent heated air from reentering the cooling package and affecting performance.

The charge air cooler shall be a cross-flow design constructed completely of aluminum with cast tanks. All charge air cooler tubes shall be formed from aluminized steel tubing and installed with silicone hump hoses and stainless steel "constant torque" style clamps meeting the engine manufacturer's requirements.

The radiator and charge air cooler shall be removable through the bottom of the chassis.

ENGINE COOLING SYSTEM PROTECTION

The engine cooling system shall include a recirculation shield designed to act as a light duty skid plate below the radiator to provide additional protection for the engine cooling system from light impacts, stones, and road debris.

ENGINE COOLANT

The cooling package shall include Extended Life Coolant (ELC). The use of ELC provides longer intervals between coolant changes over standard coolants providing improved performance. The coolant shall contain a 50/50 mix of ethylene glycol and de-ionized water to keep the coolant from freezing to a temperature of -34 degrees Fahrenheit.

Proposals offering supplemental coolant additives (SCA) shall not be considered, as this is part of the extended life coolant makeup.

ELECTRONIC COOLANT LEVEL INDICATOR

The instrument panel shall feature a low engine coolant indicator light which shall be located in the center of the instrument panel. An audible tone alarm shall also be provided to warn of a low coolant incident.

ENGINE PUMP HEAT EXCHANGER

A single bundle type coolant to water heat exchanger shall be installed between the engine and the radiator. The heat exchanger shall be designed to prohibit water from the pump from coming in contact with the engine coolant. This shall allow the use of water from the discharge side of the pump to assist in cooling the engine.

COOLANT HOSES

The cooling systems hose shall be formed silicone hose and formed aluminized steel tubing and include stainless steel constant torque band clamps.

ENGINE COOLANT OVERFLOW BOTTLE

A remote engine coolant overflow expansion bottle shall be provided in the case of over filling the coolant system. The overflow bottle shall capture the expansion fluid or overfill rather than allow the fluid to drain on the ground.

ENGINE EXHAUST SYSTEM

The exhaust system shall include an end-in end-out horizontally mounted single module after treatment device, and downpipe from the charge air cooled turbo. The single module shall include four temperature sensors, diesel particulate filter (DPF), urea dosing module (UL2), and a selective catalytic reduction (SCR) catalyst to meet current EPA standards. The selective catalytic reduction catalyst utilizes a diesel exhaust fluid solution consisting of urea and purified water to convert NOx into nitrogen, water, and trace amounts of carbon dioxide. The solution shall be mixed and injected into the system through the DPF and SCR.

The system shall utilize 0.07 inch thick stainless steel exhaust tubing between the engine turbo and the DPF. Zero leak clamps seal all system joints between the turbo and DPF.

The single module after treatment through the end of the tailpipe shall be connected with zero leak clamps. The discharge shall terminate horizontally on the right side of the vehicle ahead of the rear tires.

The exhaust system after treatment module shall be mounted below the frame in the outboard position.

DIESEL EXHAUST FLUID TANK

The exhaust system shall include a molded cross linked polyethylene tank for Diesel Exhaust Fluid (DEF). The tank shall have a capacity of six (6) usable gallons and shall be mounted on the left hand side of the chassis frame behind the batteries below the frame.

The DEF tank shall be designed with capacity for expansion in case of fluid freezing. Engine coolant, which shall be thermostatically controlled, shall be run through lines in the tank to help prevent the DEF from freezing and to provide a means of thawing the fluid if it should become frozen.

The tank fill tube shall be routed under the rear of the cab with the fill neck and splash guard accessible in the top rear step.

ENGINE EXHAUST ACCESSORIES

An exhaust temperature mitigation device shall be shipped loose for installation by the body manufacturer on the vehicle. The temperature mitigation device shall lower the temperature of the exhaust by combining ambient air with the exhaust gasses at the exhaust outlet.

ENGINE EXHAUST WRAP

The exhaust tubing between the engine turbo and the diesel particulate filter (DPF) shall be wrapped with a thermal cover in order to retain the necessary heat for DPF regeneration. The exhaust wrap shall also help protect surrounding components from radiant heat which can be transferred from the exhaust.

The exhaust flex joint shall not include the thermal exhaust wrap.

EMISSIONS SYSTEMS WARRANTY

Purchaser shall receive a Regulated Emissions Systems Five (5) Years or 100,000 Miles limited warranty in accordance with, and subject to, warranty certificate RFW0140. The warranty certificate is incorporated by reference into this proposal, and included with this proposal or available upon request.

TRANSMISSION

The drive train shall include an Allison model EVS 3000 torque converting, automatic transmission which shall include electronic controls. The transmission shall feature two (2) 10-bolt PTO pads located on the converter housing.

The transmission shall include two (2) internal oil filters and Castrol TranSynd™ synthetic TES 295 transmission fluid which shall be utilized in the lubrication of the EVS transmission. An electronic oil level sensor shall be included with the readout located in the shift selector.

The transmission gear ratios shall be:

1st	3.49:1
2nd	1.86:1
3rd	1.41:1
4th	1.00:1
5th	0.75:1
6th	0.65:1 (if applicable)
Rev	5.03:1

TRANSMISSION MODE PROGRAMMING

The transmission, upon start-up, will automatically select a four (4) speed operation. The fifth speed over drive shall be available with the activation of the mode button on the shifting pad.

TRANSMISSION FEATURE PROGRAMMING

The Allison Gen V/VI-E transmission EVS group package number 127 shall contain the 198 vocational package in consideration of the duty of this apparatus as a pumper. This package shall incorporate an automatic neutral with selector override. This feature commands the transmission to neutral when the park brake is applied, regardless of drive range requested on the shift selector. This requires re-selecting drive range to shift out of neutral for the override.

This package shall be coupled with the use of a split shaft PTO and incorporate pumping circuits. These circuits shall be used allowing the vehicle to operate in the fourth range lockup while operating the pump mode due to the 1 to 1 ratio through the transmission, therefore the output speed of the engine is the input speed to the pump. The pump output can be easily calculated by using this input speed and the drive ratio of the pump itself to rate the gallons of water the pump can provide.

A transmission interface connector shall be provided in the cab. This package shall contain the following input/output circuits to the transmission control module. The Gen V/VI-E transmission shall include prognostic diagnostic capabilities. These capabilities shall include the monitoring of the fluid life, filter change indication, and transmission clutch maintenance.

<u>Function ID</u>	<u>Description</u>	<u>Wire assignment</u>
Inputs		
C	PTO Request	142
J	Fire Truck Pump Mode (4th Lockup)	122 / 123
Outputs		
C	Range Indicator	145 (4th)
G	PTO Enable Output	130
	Signal Return	103

ELECTRONIC TRANSMISSION OIL LEVEL INDICATOR

The transmission fluid shall be monitored electronically and shall send a signal to activate a warning in the instrument panel when levels fall below normal.

TRANSMISSION SHIFT SELECTOR

An Allison pressure sensitive range selector touch pad shall be provided and located to the right of the driver within clear view and easy reach. The shift selector shall have a graphical Vacuum Florescent Display (VFD) capable of displaying two lines of text. The shift selector shall provide mode indication and a prognostic indicator (wrench symbol) on the digital display. The prognostics monitor various operating parameters and shall alert you when a specific maintenance function is required.

TRANSMISSION PRE-SELECT WITH AUXILIARY BRAKE

When the auxiliary brake is engaged, the transmission shall automatically shift to second gear to decrease the rate of speed assisting the secondary braking system and slowing the vehicle.

TRANSMISSION COOLING SYSTEM

The transmission shall include a water to oil cooler system located in the cooling loop between the radiator and the engine. The transmission cooling system shall meet all transmission manufacturer

requirements. The transmission cooling system shall feature continuous flow of engine bypass water to maintain uninterrupted transmission cooling.

TRANSMISSION DRAIN PLUG

The transmission shall include an original equipment manufacturer installed magnetic transmission fluid drain plug.

TRANSMISSION WARRANTY

The Allison EVS series transmission shall be warranted for a period of five (5) years with unlimited mileage. Parts and labor shall be included in the warranty.

PTO LOCATION

The transmission shall have two (2) power take off (PTO) mounting locations, one (1) in the 8:00 o'clock position and one (1) in the 4:00 o'clock position.

DRIVELINE

All drivelines shall be heavy duty metal tube and equipped with MSI 1710 series universal joints. The shafts shall be dynamically balanced prior to installation to alleviate future vibration. In areas of the driveline where a slip shaft is required, the splined slip joint shall be coated with Glide Coat[®]. The drivelines shall include Meritor brand u-joints with thrust washers.

MIDSHIP PUMP / GEARBOX

A temporary jackshaft driveline shall be installed by the chassis manufacturer to accommodate the midship split shaft pump as specified by the apparatus manufacturer.

MIDSHIP PUMP / GEARBOX MODEL

The midship pump/gearbox provisions shall be for a Hale DSD forward pump.

MIDSHIP PUMP GEARBOX DROP

The Hale pump gearbox shall have an "L" (long) drop length.

MIDSHIP PUMP RATIO

The ratio for the midship pump shall be 2.28:1 (23).

MIDSHIP PUMP LOCATION C/L SUCTION TO C/L REAR AXLE

The midship pump shall be located so the dimension from the centerline of the suction to the centerline of the rear axle is 102.00 inches.

PUMP SHIFT CONTROLS

One (1) air pump shift control panel shall be located on the left hand side of the engine tunnel, integrated with the shifter pod. The following shall be provided on the panel: a three (3) position control lever; an engraved PUMP ENGAGED identification light; and an engraved OK TO PUMP identification light. The pump shift control panel shall be black with a yellow border outline and shall include pump instructions. An instruction plate describing the transmission shift selector position used for pumping shall be provided and located so it can be read from the driver's position per NFPA **16.10.1.3**. The road mode shall be selected when the control lever is in the forward position and pump mode shall be selected when the control lever is in the rearward position.

The control lever center position shall exhaust air from both pump and road sides of the pump gear box shift cylinder.

PUMP SHIFT CONTROL PLUMBING

Air connections shall be provided from the air supply tank to the pump shift control valve and from the pump shift control valve to the frame mounted bracket. The frame mounted bracket shall include labeling identifying the pump and road connection points with threaded 0.25 inch NPT fittings on the solenoid for attaching the customer installed pump. The air supply shall be pressure protected from service brake system.

FUEL FILTER/WATER SEPARATOR

The fuel system shall have a Fleetguard FS20121 fuel filter/water separator as a primary filter. The fuel filter shall have a drain valve.

A water in fuel sensor shall be provided and wired to an instrument panel lamp and audible alarm to indicate when water is present in the fuel/water separator.

A secondary fuel filter shall be included as approved by the engine manufacturer.

FUEL LINES

The fuel system supply and return lines installed from the fuel tank to the engine shall be reinforced nylon tubing rated for diesel fuel. The fuel lines shall be brown in color and connected with brass fittings.

ELECTRIC FUEL PRIMER

Integral to the engine assembly is an electric lift pump that serves the purpose of pre-filter fuel priming.

FUEL TANK

The fuel tank shall have a capacity of fifty (50) gallons and shall measure 35.00 inches in width X 15.00 inches in height X 24.00 inches in length.

The baffled tank shall have a vent port to facilitate venting to the top of the fill neck for rapid filling without "blow-back" and a roll over ball check vent for temperature related fuel expansion and draw.

The tank is designed with dual draw tubes and sender flanges. The tank shall have 2.00 inch NPT fill ports for right or left hand fill. A 0.50 inch NPT drain plug shall be centered in the bottom of the tank.

The fuel tank shall be mounted below the frame, behind the rear axle. Two (2) three-piece strap hanger assemblies with "U" straps bolted midway on the fuel tank front and rear shall be utilized to allow the tank to be easily lowered and removed for service purposes. Rubber isolating pads shall be provided between the tank and the upper tank mounting brackets. Strap mounting studs through the rail, hidden behind the body shall not be acceptable.

FUEL TANK MATERIAL AND FINISH

The fuel tank shall be constructed of 12 gauge aluminized steel. The exterior of the tank shall be powder coated black and then painted to match the frame components.

All powder coatings, primers and paint shall be compatible with all metals, pretreatments and primers used. The cross hatch adhesion test per ASTM D3359 Method B, results to be 5B minimum. The pencil hardness test per ASTM D3363 shall have a final post-curved pencil hardness of H-2H. The direct impact resistance test per ASTM D2794, results to be 5B minimum.

Any proposals offering painted fuel tanks with variations from the above process shall not be accepted. The film thickness of vendor supplied parts shall also be sufficient to meet the performance standards as stated above.

FUEL TANK STRAP MATERIAL

The fuel tank straps shall be constructed of ASTM A-36 steel. The fuel tank straps shall be powder coated black and then painted to match the frame components if possible.

FUEL TANK FILL PORT

The fuel tank fill ports shall be offset with the left fill port located in the rearward position and the right fill port located in the middle position on the fuel tank.

FUEL TANK DRAIN PLUG

A 0.5 inch NPT magnetic drain plug shall be centered in the bottom of the fuel tank.

FRONT AXLE

The front axle shall be a Meritor Easy Steer Non drive front axle, model number MFS-20. The axle shall include a 3.74 inch drop and a 71.00 inch king pin intersection (KPI). The axle shall include a conventional style hub with a standard knuckle. The weight capacity for the axle shall be rated to 21,500 pounds FAWR.

FRONT AXLE WARRANTY

The front axle shall be warranted by Meritor for five (5) years with unlimited miles under the general service application. Details of the Meritor warranty are provided on the PDF document attached to this option.

FRONT WHEEL BEARING LUBRICATION

The front axle wheel bearings shall be lubricated with oil. The oil level can be visually checked via clear inspection windows in the front axle hubs.

FRONT SHOCK ABSORBERS

Two (2) Bilstein inert, nitrogen gas filled shock absorbers shall be provided and installed as part of the front suspension system. The shocks shall be a monotubular design and fabricated using a special extrusion method, utilizing a single blank of steel without a welded seam, achieving an extremely tight peak-to-valley tolerance and maintains consistent wall thickness. The monotubular design shall provide superior strength while maximizing heat dissipation and shock life.

The ride afforded through the use of a gas shock is more consistent and shall not deteriorate with heat, the same way a conventional oil filled hydraulic shock would.

The Bilstein front shocks shall include a digressive working piston assembly allowing independent tuning of the compression and rebound damping forces to provide optimum ride and comfort without compromise. The working piston design shall feature fewer parts than most conventional twin tube and “road sensing” shock designs and shall contribute to the durability and long life of the Bilstein shock absorbers.

Proposals offering the use of conventional twin tube or “road sensing” designed shocks shall not be considered.

FRONT SUSPENSION

The front suspension shall include a ten (10) leaf spring pack in which the longest leaf measures 54.00 inch long and 4.00 inches wide and shall include a military double wrapped front eye. Both spring eyes shall have a case hardened threaded bushing installed with lubrication counter bore and lubrication land off cross bore with grease fitting. The spring capacity shall be rated at 21,500 pounds.

STEERING COLUMN/ WHEEL

The cab shall include a Douglas Autotech steering column which shall include a seven (7) position tilt, a 2.25 inch telescopic adjustment, and an 18.00 inch, two (2) spoke steering wheel located at the driver’s position. The steering wheel shall be covered with black polyurethane foam padding.

The steering column shall contain a horn button, self-canceling turn signal switch, four-way hazard switch and headlamp dimmer switch.

ELECTRONIC POWER STEERING FLUID LEVEL INDICATOR

The power steering fluid shall be monitored electronically and shall send a signal to activate an audible alarm and visual warning in the instrument panel when fluid level falls below normal.

POWER STEERING PUMP

The hydraulic power steering pump shall be a TRW PS and shall be gear driven from the engine. The pump shall be a balanced, positive displacement, sliding vane type. The power steering system shall include an oil to air passive cooler.

FRONT AXLE CRAMP ANGLE

The chassis shall have a front axle cramp angle of 48-degrees to the left and 44-degrees to the right.

POWER STEERING GEAR

The power steering gear shall be a TRW model TAS 65 with an assist cylinder.

CHASSIS ALIGNMENT

The chassis frame rails shall be measured to insure the length is correct and cross checked to make sure they run parallel and are square to each other. The front and rear axles shall be laser aligned. The front tires and wheels shall be aligned and toe-in set on the front tires by the chassis manufacturer.

REAR AXLE

The rear axle shall be a Meritor model RS-30-185 single drive axle. The axle shall include precision forged, single reduction differential gearing, and shall have a fire service rated capacity of 33,000 pounds.

The axle shall be built of superior construction and quality components to provide the rugged dependability needed to stand up to the fire industry's demands. The axle shall include rectangular shaped, hot-formed housing with a standard wall thickness of 0.56 of an inch for extra strength and rigidity and a rigid differential case for high axle strength and reduced maintenance.

The axle shall have heavy-duty Hypoid gearing for longer life, greater strength and quieter operation. Industry-standard wheel ends for compatibility with both disc and drum brakes, and unitized oil seal technology to keep lubricant in and help prevent contaminant damage will be used.

REAR AXLE DIFFERENTIAL LUBRICATION

The rear axle differential shall be lubricated with oil.

REAR AXLE WARRANTY

The rear axle shall be warranted by Meritor for five (5) years with unlimited miles under the general service application. Details of the Meritor warranty are provided on the PDF document attached to this option.

REAR WHEEL BEARING LUBRICATION

The rear axle wheel bearings shall be lubricated with oil.

VEHICLE TOP SPEED

The top speed of the vehicle shall be approximately 68 MPH +/-2 MPH at governed engine RPM.

REAR SUSPENSION

The single rear axle shall feature a Reyco 79KB vari-rate, self-leveling captive slipper type conventional multi-leaf spring suspension, with 57.50 inch X 3.00 inch springs. One (1) adjustable and one (1) fixed torque rod shall be provided.

The rear suspension capacity shall be rated from 21,000 to 31,500 pounds.

TIRE INTERMITTENT SERVICE RATING

The chassis shall be rated using Intermittent Service ratings provided to the emergency vehicle market by the tire manufacturers as the basis for determining the maximum vehicle load and speed.

FRONT TIRE

The front tires shall be Michelin 385/65R22.5 "L" tubeless radial X Multi HL Z regional tread.

The front tire stamped load capacity shall be 22,000 pounds per axle with a nominal speed rating of 68 miles per hour when properly inflated to 130 pounds per square inch.

The Michelin Intermittent Service Rating maximum load capacity shall be 23,540 pounds per axle with a maximum speed of 68 miles per hour when properly inflated to 130 pounds per square inch.

The Michelin Intermittent Service Rating maximum speed capacity shall be 22,000 pounds per axle with a speed rating of 75 miles per hour when properly inflated to 130 pounds per square inch.

The Michelin Intermittent Service Rating limits the operation of the emergency vehicle to no more than fifty (50) miles of continuous operation under maximum recommended payload, or without stopping for at least twenty (20) minutes. The emergency vehicle must reduce its speed to no more than 50 MPH after the first fifty (50) miles of travel.

REAR TIRE

The rear tires shall be Michelin 315/80R-22.5 20PR "L" tubeless radial XDN2 Grip all weather tread.

The rear tire stamped load capacity shall be 33,080 pounds per axle with a nominal speed rating of 75 miles per hour when properly inflated to 130 pounds per square inch.

The Michelin Intermittent Service Rating maximum load capacity shall be 35,396 pounds per axle with a maximum speed of 75 miles per hour when properly inflated to 130 pounds per square inch.

The Michelin Intermittent Service Rating maximum speed capacity shall match the nominal speed rating.

The Michelin Intermittent Service Rating limits the operation of the emergency vehicle to no more than fifty (50) miles of continuous operation under maximum recommended payload, or without stopping for

at least twenty (20) minutes. The emergency vehicle must reduce its speed to no more than 50 MPH after the first fifty (50) miles of travel.

REAR AXLE RATIO

The rear axle ratio shall be 5.13:1.

TIRE PRESSURE INDICATOR

There shall be electronic chrome LED valve caps shipped loose for installation by the OEM which shall illuminate with a red LED when tire pressure drops 8psi provided. The valve caps are self-calibrating and set to the pressure of the tire upon installation.

FRONT WHEEL

The front wheels shall be Alcoa hub piloted, 22.50 inch X 12.25 inch aluminum wheels featuring a mirror polish on the outer face. The hub piloted mounting system shall provide easy installation and shall include two-piece flange nuts.

REAR WHEEL

The outer rear wheels shall be Alcoa hub piloted, 22.50 inch X 9.00 inch aluminum wheels with a mirror polished outer surface. The inner rear wheels shall be Alcoa hub piloted, 22.50 inch X 9.00 inch aluminum wheels with bright machine finish. The hub piloted mounting system shall provide easy installation and shall include two-piece flange nuts.

BRAKE SYSTEM

A rapid build-up air brake system shall be provided. The air brakes shall include, at a minimum, a two (2) air tank, three (3) reservoir system with a total of 4152 cubic inch of air capacity. A floor mounted treadle valve shall be mounted inside the cab for graduated control of applying and releasing the brakes. An inversion valve shall be installed to provide a service brake application in the unlikely event of primary air supply loss. All air reservoirs provided on the chassis shall be labeled for identification.

The rear axle spring brakes shall automatically apply in any situation when the air pressure falls below 25 PSI and shall include a mechanical means for releasing the spring brakes when necessary. An audible alarm shall designate when the system air pressure is below 60 PSI.

A four (4) sensor, four (4) modulator anti-lock braking system (ABS) shall be installed on the front and rear axles in order to prevent the brakes from locking or skidding while braking during hard stops or on icy or wet surfaces. This in turn shall allow the driver to maintain steering control under heavy braking and in most instances, shorten the braking distance. The electronic monitoring system shall incorporate diagonal circuitry which shall monitor wheel speed during braking through a sensor and tone ring on each wheel. A dash mounted ABS lamp shall be provided to notify the driver of a system malfunction. The ABS system shall automatically disengage the auxiliary braking system device when required. The speedometer screen shall be capable of reporting all active defaults using PID/SID and FMI standards.

Additional safety shall be accommodated through Automatic Traction Control (ATC) which shall be installed on the single rear axle. The ATC system shall apply the ABS when the drive wheels loose

traction. The system shall scale the electronic engine throttle back to prevent wheel spin while accelerating on ice or wet surfaces.

A momentary rocker style switch shall be provided and properly labeled "mud/snow". When the switch is pressed once, the system shall allow a momentary wheel slip to obtain traction under extreme mud and snow conditions. During this condition the ATC light and the light on the rocker switch shall blink continuously notifying the driver of activation. Pressing the switch again shall deactivate the mud/snow feature.

The Electronic Stability Control (ESC) unit is a functional extension of the electronic braking system. It is able to detect any skidding of the vehicle about its vertical axis as well as any rollover tendency. The control unit comprises an angular-speed sensor that measures the vehicle's motion about the vertical axis, caused, for instance, by cornering or by skidding on a slippery road surface. An acceleration sensor measures the vehicle's lateral acceleration. The Controller Area Network (CAN) bus provides information on the steering angle. On the basis of lateral acceleration and steering angle, an integrated microcontroller calculates a theoretical angular speed for the stable vehicle condition.

FRONT BRAKES

The front brakes shall be Meritor EX225 Disc Plus disc brakes with 17.00 inch vented rotors.

REAR BRAKES

The rear brakes shall be Meritor 16.50 inch X 8.63 inch S-cam drum type. The brakes shall feature a cast iron shoe.

PARK BRAKE

Upon application of the push-pull valve in the cab, the rear brakes will engage via mechanical spring force. This is accomplished by dual chamber rear brakes, satisfying the FMVSS parking brake requirements.

PARK BRAKE CONTROL

A Meritor-Wabco manual hand control push-pull style valve shall operate the parking brake.

The parking brake actuation valve shall be mounted to the left side of the engine tunnel integrated into the transmission shift pod console within easy access of the driver.

REAR BRAKE SLACK ADJUSTERS

Haldex rear brake automatic slack adjusters shall be installed on the axle.

AIR DRYER

The brake system shall include a Wabco System Saver 1200 air dryer with an integral 100 watt heater with a Metri-Pack sealed connector. The air dryer incorporates an internal turbo cutoff valve that closes the path between the air compressor and air dryer purge valve during the compressor "unload" cycle. The turbo cutoff valve allows purging of moisture and contaminants without the loss of turbo boost

pressure. The air dryer shall be located on the right hand frame rail forward of the front wheel behind the right hand cab step.

FRONT BRAKE CHAMBERS

The front brakes shall be provided with MGM type 24 long stroke brake chambers.

REAR BRAKE CHAMBERS

The rear axle shall include TSE 30/36 brake chambers which shall convert the energy of compressed air into mechanical force and motion. This shall actuate the brake camshaft, which in turn shall operate the foundational brake mechanism forcing the brake shoes against the brake drum. The TSE Type 36 brake chamber has a 36.00 square inch effective area.

AIR COMPRESSOR

The air compressor provided for the engine shall be a Wabco® SS318 single cylinder pass-through drive type compressor which shall be capable of producing 18.7 CFM at 1200 engine RPMs. The air compressor shall feature a higher delivery efficiency translating to more air delivery per horsepower absorbed. The compressor shall include an aluminum cylinder head which shall improve cooling, reduce weight and decrease carbon formation. Superior piston and bore finishing technology shall reduce oil consumption and significantly increasing the system component life.

AIR GOVERNOR

An air governor shall be provided to control the cut-in and cut-out pressures of the engine mounted air compressor. The governor shall be calibrated to meet FMVSS requirements. The air governor shall be located on the air dryer bracket.

MOISTURE EJECTORS

Manual pet-cock type drain valves shall be installed on all reservoirs of the air supply system.

AIR SUPPLY LINES

The air system on the chassis shall be plumbed with color coded reinforced nylon tubing air lines. The primary (rear) brake line shall be green, the secondary (front) brake line red, the parking brake line orange and the auxiliary (outlet) will be blue.

Push to connect type fittings shall be used on the nylon tubing. All drop hoses shall include fiber reinforced neoprene covered hoses.

WHEELBASE

The chassis wheelbase shall be 198.50 inches.

REAR OVERHANG

The chassis rear overhang shall be 46.00 inches.

FRAME

The frame shall consist of double rails running parallel to each other with cross members forming a ladder style frame. The frame rails shall be formed in the shape of a "C" channel, with the outer rail measuring 10.25 inches high X 3.50 inches deep upper and lower flanges X 0.38 inches thick with an inner channel of 9.44 inches high X 3.13 inches deep and 0.38 inches thick. Each rail shall be constructed of 110,000 psi minimum yield high strength low alloy steel. Each double rail section shall be rated by a Resistance Bending Moment (RBM) minimum of 3,213,100 inch pounds and have a minimum section modulus of 29.21 cubic inches. The frame shall measure 35.00 inches in width.

Proposals calculating the frame strength using the "box method" shall not be considered.

Proposals including heat treated rails shall not be considered. Heat treating frame rails produces rails that are not uniform in their mechanical properties throughout the length of the rail. Rails made of high strength, low alloy steel are already at the required yield strength prior to forming the rail.

A minimum of seven (7) fully gusseted 0.25 inch thick cross members shall be installed. The inclusion of the body mounting, or bumper mounting shall not be considered as a cross member. The cross members shall be attached using zinc coated grade 8 fasteners. The bolt heads shall be flanged type, held in place by distorted thread flanged lock nuts. Each cross member shall be mounted to the frame rails utilizing a minimum of 0.25 inch thick gusset reinforcement plates at all corners balancing the area of force throughout the entire frame.

Any proposals not including additional reinforcement for each cross member shall not be considered.

All relief areas shall be cut in with a minimum 2.00 inch radius at intersection points with the edges ground to a smooth finish to prevent a stress concentration point.

FRAME PAINT

The frame rails shall be hot dip galvanized prior to assembly and attachment of any components. The components that shall be galvanized shall include:

Main frame "C" channel or channels

The frame parts which are not galvanized shall be powder coated prior to any attachment of components. Parts which shall be powder coated shall include but are not limited to:

Steering gear bracket
Front splayed rails and fish plates
Bumper extensions
Cross members
Cross member gussets
Fuel tank mounting brackets
Fuel tank straps (unless material/finish is specified in 3130 subcat)
Air tanks (unless color coded tanks are specified in 3205 subcat)
Air tank mounting brackets

Exhaust mounting brackets
Air cleaner skid plate
Radiator skid plate
Battery supports, battery trays and battery covers

Other non-galvanized under carriage components which are received from the suppliers with coatings already applied shall include but are not limited to:

Suspension components
Front and rear axles

All powder coatings, primers and paint used on the non-galvanized components shall be compatible with all metals, pretreatments and primers used. The cross hatch adhesion test per ASTM D3359 shall not have a fail of more than ten (10) squares. The pencil hardness test per ASTM D3363 shall have a final post-curved pencil hardness of H-2H. The direct impact resistance test per ASTM D2794 shall have an impact resistance of 120.00 inches per pound at 2 mils.

FRAME ASSEMBLY STRUCTURAL

Purchaser shall receive a Frame Assembly Structural Five (5) Years limited warranty in accordance with, and subject to, warranty certificate RFW0301. The warranty certificate is incorporated by reference into this proposal, and included with this proposal or available upon request.

FRAME RAIL CORROSION

Purchaser shall receive a Frame Rail Corrosion (Zinc Plate and Powder Coat) Ten (10) Years or 75,000 Miles limited warranty in accordance with, and subject to, warranty certificate RFW0317. The warranty certificate is incorporated by reference into this proposal, and included with this proposal or available upon request.

FRAME COMPONENTS CORROSION

Purchaser shall receive a Frame Components Corrosion (Powder Coat) One (1) Year or 18,000 Miles limited warranty in accordance with, and subject to, warranty certificate RFW0313. The warranty certificate is incorporated by reference into this proposal, and included with this proposal or available upon request.

FRONT BUMPER

A one piece, two (2) rib wrap-around style, polished stainless steel front bumper shall be provided. The material shall be 10 gauge 304 stainless steel, 12.00 inches high and 99.00 inches wide.

FRONT BUMPER EXTENSION LENGTH

The front bumper shall be extended approximately 24.00 inches ahead of the cab.

FRONT BUMPER SUCTION PROVISION

The bumper apron shall include a 5.00 inch stainless steel pipe intended for use as a suction intake for the pump. The suction pipe shall be routed from the right-hand front bumper area to the area rear of the front axle near the back of the cab.

The front of the suction pipe shall be designed to terminate at approximately 2.00 inches in front of the front face of the cab behind the bumper face on the right-hand side in the far outboard position.

The forward end of the suction pipe shall include a Victaulic groove for customer completed suction routing and hose/intake connection point. The rear of the suction shall include a Victaulic groove for connecting to the pump plumbing. The suction pipe shall also include a 0.50 inch NPT port intended as a primer assist connection.

The apparatus manufacturer shall plumb the suction pipe to the pump and shall provide all valves as required.

FRONT BUMPER APRON

The 24.00 inch extended front bumper shall include an apron constructed of 0.19 inch thick embossed aluminum tread plate.

The apron shall be installed between the bumper and the front face of the cab affixed using stainless steel bolts attaching the apron to the top bumper flange.

FRONT BUMPER DISCHARGE

The chassis shall include frame mounted 2.00 inch diameter plumbed pipe intended for use as a discharge trash line. The discharge pipe shall be routed from the left hand front splay rail area behind the bumper to the area rear of the front axle, ahead of the battery box.

The discharge shall pipe shall be a, 2.00 inch stainless steel schedule 10 tube. The discharge shall include a Victaulic groove for connecting to the pump and discharge hose plumbing on each end of the tube.

The apparatus manufacturer shall plumb the discharge pipe to the pump and shall provide all valves as required.

FRONT BUMPER COMPARTMENT CENTER

The front bumper shall include a compartment in the bumper apron located in the center between the frame rails which may be used as a hose well. The compartment shall be constructed of 0.13 inch 5052-H32 grade aluminum and shall include drain holes in the bottom corners to allow excess moisture to escape. The compartment shall include a cover constructed of 0.19 inch thick bright embossed aluminum tread plate.

FRONT BUMPER COMPARTMENT COVER HARDWARE

The front bumper compartment cover(s) shall include gas cylinder stays which shall hold the cover open. Each cover shall be held in the closed position via a D-ring style latch.

MECHANICAL SIREN

The front bumper shall include an electro mechanical Federal Q2B™ siren, which shall be streamlined, chrome-plated and shall produce 123 decibels of sound at 10.00 feet. The Q2B™ siren produces a distinctive warning sound that is recognizable at long distances. A unique clutch design provides a longer coast down sound while reducing the amp draw to 100 amps. The siren shall measure 10.50 inches wide X 10.00 inches high X 14.00 inches deep. The siren shall include a pedestal mount to surface mount on a horizontal surface.

MECHANICAL SIREN LOCATION

The siren shall be pedestal mounted on the bumper apron on the furthest outboard section of the bumper on the driver side.

AIR HORN

The front bumper shall include two (2) Hadley brand E-Tone air horns which shall measure 21.00 inches long with a 6.00 inch round flare. The air horns shall be trumpet style with a chrome finish on the exterior and a painted finish deep inside the trumpet.

AIR HORN LOCATION

The air horns shall be recess mounted in the front bumper face, one (1) on the right side of the bumper in the inboard position relative to the right hand frame rail and one (1) on the left side of the bumper in the inboard position relative to the left hand frame rail.

AIR HORN RESERVOIR

One (1) air reservoir, with a 1200 cubic inch capacity, shall be installed on the chassis to act as a supply tank for operating air horns. The reservoir shall be isolated with a 90 PSI pressure protection valve on the reservoir supply side to prevent depletion of the air to the air brake system.

ELECTRONIC SIREN SPEAKER

There shall be one (1) Cast Products Inc. model SA4301, 100 watt speaker provided. The speaker shall measure 6.20 inches tall X 7.36 inches wide X 3.06 inches deep. The speaker shall include a flat mounting flange which shall be polished aluminum.

ELECTRONIC SIREN SPEAKER LOCATION

The electronic siren speaker shall be located on the front bumper face on the right side outboard of the frame rail in the far outboard position.

FRONT BUMPER TOW HOOKS

Two (2) heavy duty tow hooks, painted to match the frame components, shall be installed below the front bumper in the forward position, bolted directly to the underside of each chassis frame rail with grade 8 bolts.

CAB TILT SYSTEM

The entire cab shall be capable of tilting approximately 45-degrees to allow for easy maintenance of the engine and transmission. The cab tilt pump assembly shall be located on the right side of the chassis above the battery box.

The electric-over-hydraulic lift system shall include an ignition interlock and red cab lock down indicator lamp on the tilt control which shall illuminate when holding the “Down” button to indicate safe road operation.

It shall be necessary to activate the master battery switch and set the parking brake in order to tilt the cab. As a third precaution the ignition switch must be turned off to complete the cab tilt interlock safety circuit.

Two (2) spring-loaded hydraulic hold down hooks located outboard of the frame shall be installed to hold the cab securely to the frame. Once the hold-down hooks are set in place, it shall take the application of pressure from the hydraulic cab tilt lift pump to release the hooks.

Two (2) cab tilt cylinders shall be provided with velocity fuses in each cylinder port. The cab tilt pivots shall be 1.90 inch ball and be anchored to frame brackets with 1.25 inch diameter studs.

A steel safety channel assembly, painted safety yellow shall be installed on the right side cab lift cylinder to prevent accidental cab lowering. The safety channel assembly shall fall over the lift cylinder when the cab is in the fully tilted position. A cable release system shall also be provided to retract the safety channel assembly from the lift cylinder to allow the lowering of the cab.

CAB TILT CONTROL RECEPTACLE

The cab tilt control cable shall include a receptacle which shall be temporarily located on the right hand chassis rail rear of the cab to provide a place to plug in the cab tilt remote control pendant. The tilt pump shall include 8.00 feet of cable with a six (6) pin Deutsch receptacle with a cap.

The remote control pendant shall include 20.00 feet of cable with a mating Deutsch connector. The remote control pendant shall be shipped loose with the chassis.

CAB TILT LOCK DOWN INDICATOR

The cab dash shall include a message located within the dual air pressure gauge which shall alert the driver when the cab is unlocked and ajar. The alert message shall cease to be displayed when the cab is in the fully lowered position and the hold down hooks are secured and locked to the cab mounts.

In addition to the alert message an audible alarm shall sound when the cab is unlocked and ajar with the parking brake released.

CAB WINDSHIELD

The cab windshield shall have a surface area of 2825.00 square inches and be of a two (2) piece wraparound design for maximum visibility.

The glass utilized for the windshield shall include standard automotive tint. The left and right windshield shall be fully interchangeable thereby minimizing stocking and replacement costs.

Each windshield shall be installed using black self locking window rubber.

GLASS FRONT DOOR

The front cab doors shall include a window which is 27.00 inches in width X 26.00 inches in height. These windows shall have the capability to roll down completely into the door housing. This shall be accomplished using electric actuation. The left and right front door windows shall be controlled using a switch on each respective side inner door panel. The driver's door shall include a switch for each powered door window in the cab.

There shall be an irregular shaped fixed window which shall measure 2.50 inches wide at the top, 8.00 inches wide at the bottom X 26.00 inches in height, more commonly known as "cozy glass" ahead of the front door roll down windows.

The windows shall be mounted within the frame of the front doors trimmed with a black anodized ring on the exterior.

GLASS TINT FRONT DOOR

The windows located in the left and right front doors shall have a standard green automotive tint which shall allow seventy-five percent (75%) light transmittance.

GLASS REAR DOOR RH

The rear right hand side crew door shall include a window which is 27.00 inches in width X 26.00 inches in height. The window shall be a powered type and shall be controlled by a switch on the door panel ledge and on the driver's control panel.

GLASS TINT REAR DOOR RIGHT HAND

The window located in the right hand side rear door shall include a standard green automotive tint which shall allow seventy-five percent (75%) light transmittance.

GLASS REAR DOOR LH

The rear left hand side crew door shall include a window which is 27.00 inches in width X 26.00 inches in height. The window shall be a powered type and shall be controlled by a switch on the door panel ledge and on the driver's control panel.

GLASS TINT REAR DOOR LEFT HAND

The window located in the left hand side rear door shall include a standard green automotive tint which shall allow seventy-five percent (75%) light transmittance.

GLASS SIDE MID RH

The cab shall include a window on the right side behind the front and ahead of the crew door which shall measure 16.00 inches wide X 26.00 inches high. This window shall be fixed within this space and shall be rectangular in shape. The window shall be mounted using self locking window rubber. The glass utilized for this window shall include a green automotive tint unless otherwise noted.

GLASS TINT SIDE MID RIGHT HAND

The window located on the right hand side of the cab between the front and rear doors shall include a standard green automotive tint which shall allow seventy-five percent (75%) light transmittance.

GLASS SIDE MID LH

The cab shall include a window on the left side behind the front door and ahead of the crew door and above the wheel well which shall measure 16.00 inches wide X 26.00 inches high. This window shall be fixed within this space and shall be rectangular in shape. The window shall be mounted using self locking window rubber. The glass utilized for this window shall include a green automotive tint unless otherwise noted.

GLASS TINT SIDE MID LEFT HAND

The window located on the left hand side of the cab between the front and rear doors shall include a standard green automotive tint which shall allow seventy-five percent (75%) light transmittance.

CLIMATE CONTROL

The cab shall include a 57,500 BTU @ 425 CFM front overhead heater/defroster which shall be provided and installed above the windshield between the sun visors.

The cab shall also include a combination heater air-conditioning unit mounted on the engine tunnel. This unit shall offer eight (8) adjustable louvers, four (4) forward facing and four (4) rearward facing, a temperature control valve and two (2) blowers offering three (3) speeds which shall be capable of circulating 550 cubic feet of air per minute. The unit shall be rated for 42,500 BTU/Hr of cooling and 36,000 BTU/Hr of heating.

All defrost/heating systems shall be plumbed with one (1) seasonal shut-off valve at the front corner on the right side of the cab.

The air conditioner lines shall be a mixture of custom bend zinc coated steel fittings and Aeroquip flexible hose with Aeroquip EZ clip fittings.

CLIMATE CONTROL DRAIN

The climate control system shall include a gravity drain for water management. The gravity drain shall remove condensation from the air conditioning system without additional mechanical assistance.

CLIMATE CONTROL ACTIVATION

The heating and defrosting controls shall be located on the front overhead climate control unit. There shall be additional heating and air conditioning controls located on the engine tunnel mounted climate control unit.

A/C CONDENSER LOCATION

A roof mounted A/C condenser shall be installed centered on the cab forward of the raised roof against the slope rise.

A/C COMPRESSOR

The air-conditioning compressor shall be a belt driven, engine mounted, open type compressor that shall be capable of producing a minimum of 32,000 BTU at 1500 engine RPMs. The compressor shall utilize R-134A refrigerant and PAG oil.

UNDER CAB INSULATION

The underside of the cab tunnel surrounding the engine shall be lined with multi-layer insulation, engineered for application inside diesel engine compartments.

The insulation shall act as a noise barrier, absorbing noise thus keeping the decibel level in the cab well within NFPA recommendations. As an additional benefit, the insulation shall assist in sustaining the desired temperature within the cab interior.

The engine tunnel insulation shall measure approximately 0.30 inch thick including a multi-layer foil faced glass cloth and polyester fiber layer. The foil surface acts as protection against heat, moisture and other contaminants. The insulation shall meet or exceed FMVSS 302 flammability test.

The insulation shall be cut precisely to fit each section and sealed for additional heat and sound deflection. The insulation shall be held in place by acrylic pressure sensitive adhesive.

INTERIOR TRIM FLOOR

The floor of the cab shall be covered with a multi-layer mat consisting of 0.25 inch thick sound absorbing closed cell foam with a 0.06 inch thick non-slip vinyl surface with a pebble grain finish. The covering shall be held in place by a pressure sensitive adhesive and aluminum trim molding. All exposed seams shall be sealed with silicone caulk matching the color of the floor mat to reduce the chance of moisture and debris retention.

INTERIOR TRIM

The cab interior shall include trim on the front ceiling, rear crew ceiling, and the cab walls. It shall be easily removable to assist in maintenance. The trim shall be constructed of insulated vinyl over a hard board backing.

REAR WALL INTERIOR TRIM

The rear wall of the cab shall be trimmed with vinyl.

HEADER TRIM

The cab interior shall feature header trim over the driver and officer dash constructed of 5052-H32 Marine Grade, 0.13 inch thick aluminum.

TRIM CENTER DASH

The main center dash area shall be constructed of 5052-H32 Marine Grade, 0.13 inch thick aluminum plate. There shall be four (4) holes located on the top of the dash near each outer edge of the electrical access cover for ventilation.

TRIM LH DASH

The left hand dash shall be constructed of 5052-H32 Marine Grade, 0.13 inch thick aluminum plate for a perfect fit around the instrument panel. For increased occupant protection the extreme duty left hand dash utilizes patent pending break away technology to reduce rigidity in the event of a frontal crash. The left hand dash shall offer lower vertical surface area to the left and right of the steering column to accommodate control panels.

TRIM RH DASH

The right hand dash shall be constructed of 5052-H32 Marine Grade, 0.13 of an inch thick aluminum plate and shall include a glove compartment with a hinged door and a Mobile Data Terminal (MDT) provision. The glove compartment size will measure 14.00 inches wide X 6.38 inches high X 5.88 inches deep. The MDT provision shall be provided above the glove compartment.

ENGINE TUNNEL TRIM

The cab engine tunnel shall be covered with a multi-layer mat consisting of 0.25 inch closed cell foam with a 0.06 inch thick non-slip vinyl surface with a pebble grain finish. The mat shall be held in place by pressure sensitive adhesive. The engine tunnel mat shall be trimmed with anodized aluminum stair nosing trim for an aesthetically pleasing appearance.

POWER POINT DASH MOUNT

The cab shall include a 12 volt cigarette lighter type receptacle in the cab dash to provide a power source for 12 volt electrical equipment. The cab shall also include one (1) Blue Sea dual universal serial bus (USB) charging receptacle in the cab dash switch panel to provide a power source for USB chargeable electrical equipment. The USB port shall be capable of a 5 Volt-4.8 amp total output. The receptacles shall be wired battery direct.

STEP TRIM

Each cab entry door shall include a three step entry. The first step closest to the ground shall be constructed of polished 5032 H32 aluminum Grip Strut® grating with angled outer corners. The step shall feature a splash guard to reduce water and debris from splashing in to the step. The splash guard shall have an opening on the outer edge to allow debris and water to flow through rather than becoming trapped within the stepping surface. The lower step shall be mounted to a frame which is integral with

the construction of the cab for rigidity and strength. The middle step shall be integral with the cab construction and shall be trimmed with a Flex-Tred[®] adhesive grit surface material.

UNDER CAB ACCESS DOOR

The cab shall include an access door in the left crew step riser constructed of DA finish aluminum with a push and turn latch. The under cab access door shall provide access to the diesel exhaust fluid fill.

INTERIOR DOOR TRIM

The interior trim on the doors of the cab shall consist of an aluminum panel constructed of Marine Grade 5052-H32 0.13 of an inch thick aluminum plate. The door panels shall include a painted finish.

CAB DOOR TRIM REFLECTIVE

The interior of each door shall include high visibility reflective tape. A white reflective tape shall be provided vertically along the rear outer edge of the door. The lowest portion of each door skin shall include a reflective tape chevron with red and white stripes and a Spartan logo. The chevron tape shall measure 6.00 inches in height.

INTERIOR GRAB HANDLE "A" PILLAR

There shall be two (2) rubber covered 11.00 inch grab handles installed inside the cab, one on each "A" post at the left and right door openings. The left handle shall be located 7.88 inches above the bottom of the door window opening and the right handle shall be located 2.88 inches above the bottom of the door window opening. The handles shall assist personnel in entering and exiting the cab.

INTERIOR GRAB HANDLE FRONT DOOR

Each front door shall include one (1) ergonomically contoured 9.00 inch cast aluminum handle mounted horizontally on the interior door panels. The handles shall feature a textured black powder coat finish to assist personnel entering and exiting the cab.

INTERIOR GRAB HANDLE REAR DOOR

A black powder coated cast aluminum assist handle shall be provided on the inside of each rear crew door. A 30.00 inch long handle shall extend horizontally the width of the window just above the window sill. The handle shall assist personnel in exiting and entering the cab.

INTERIOR SOFT TRIM COLOR

The cab interior soft trim surfaces shall be gray in color.

INTERIOR TRIM SUNVISOR

The header shall include two (2) sun visors, one each side forward of the driver and officer seating positions above the windshield. Each sun visor shall be constructed of Masonite and covered with padded vinyl trim.

INTERIOR FLOOR MAT COLOR

The cab interior floor mat shall be gray in color.

CAB PAINT INTERIOR DOOR TRIM

The inner door panel surfaces shall be painted with multi-tone silver gray texture finish.

HEADER TRIM INTERIOR PAINT

The metal surfaces in the header area shall be coated with multi-tone silver gray texture finish.

TRIM CENTER DASH INTERIOR PAINT

The entire center dash shall be coated with multi-tone silver gray texture finish. Any accessory pods attached to the dash shall also be painted this color.

TRIM LH DASH INTERIOR PAINT

The left hand dash shall be painted with a multi-tone silver gray texture finish.

TRIM RIGHT HAND DASH INTERIOR PAINT

The right hand dash shall be painted with multi-tone silver gray texture finish.

DASH PANEL GROUP

The main center dash area shall include three (3) removable panels located one (1) to the right of the driver position, one (1) in the center of the dash and one (1) to the left of the officer position. The center panel shall be within comfortable reach of both the driver and officer.

SWITCHES CENTER PANEL

The center dash panel shall include twelve (12) rocker switch positions in a single row across the top of the panel.

A rocker switch with a blank legend installed directly above shall be provided for any position without a switch and legend designated by a specific option. The non-specified switches shall be two-position, black switches with a green indicator light. Each blank switch legend can be custom engraved by the body manufacturer. All switch legends shall have backlighting provided.

SWITCHES LEFT PANEL

The left dash panel shall include eight (8) switches. There shall be six (6) switches across the top of the panel and two (2) staggered on the left hand portion of the panel. Five (5) of the top row of switches shall be rocker type and the left one (1) shall be the headlight switch. The remaining switches shall consist of one (1) windshield wiper/washer control switch and one (1) instrument lamp dimmer switch.

A rocker switch with a blank legend installed directly above shall be provided for any position not designated by a specific option. The non-designated switches shall be two-position, black switches with a green indicator light. Each blank switch legend can be custom engraved by the body manufacturer. All switch legends shall have backlighting provided.

SWITCHES RIGHT PANEL

The right dash panel shall include no rocker switches or legends.

SEAT BELT WARNING

A Weldon seat belt warning system, integrated with the Vehicle Data Recorder system, shall be installed for each seat within the cab. The system shall activate a digital seat position indicator with a seat position legend and integrated audible alarm in the switch panel.

The warning system shall activate when any seat is occupied with a minimum of 60 pounds and the corresponding seat belt remains unfastened. The warning system shall also activate when any seat is occupied and the corresponding seat belt was fastened in an incorrect sequence. Once activated, the visual indicators and applicable audible alarm shall remain active until all occupied seats have the seat belts fastened.

SEAT MATERIAL

The Bostrom Firefighter seats shall include a covering of extra high strength, wear resistant fabric made of durable low seam Durawear Plus™ ballistic polyester. A PVC coating shall be bonded to the back side of the material to help protect the seats from UV rays and from being saturated or contaminated by fluids. Durawear Plus™ meets or exceeds specification of the common trade name Imperial 1800. The material meets FMVSS 302 flammability requirements.

If applicable, Theatre style seats located in the cab shall be high strength, wear resistant fabric made of durable ballistic polyester. A PVC coating shall be bonded to the back side of the material to help protect the seats from UV rays and from being saturated or contaminated by fluids. Common trade names for this material are Imperial 1200 and Durawear.

SEAT COLOR

All seats supplied with the chassis shall be gray in color. All seats shall include red seat belts.

SEAT BACK LOGO

The seat back shall include the “Spartan” logo. The logo shall be centered on the standard headrest of the seat back and on the left side of a split headrest.

SEAT DRIVER

The driver's seat shall be an H.O. Bostrom 400 Series Firefighter Sierra model seat. The seat shall feature eight-way electric positioning. The eight positions shall include up and down, fore and aft with 8.00 inches of travel, back angle adjustment and seat rake adjustment. The seat shall feature integral springs to isolate shock.

The seat shall feature an all belts to seat (ABTS) style of safety restraint. The ABTS feature shall include a three-point shoulder harness with the lap belt, automatic retractor and buckle as an integral part of the seat assembly.

The minimum vertical dimension from the seat H-point to the ceiling for this belted seating position shall be 35.00 inches measured with the seat height adjusted to the lowest position of travel.

This model of seat shall have successfully completed the static load tests set forth by FMVSS 207, 209, and 210 in effect at the time of manufacture. This testing shall include a simultaneous forward load of 3000 pounds each on the lap and shoulder belts and twenty (20) times the weight through the center of gravity.

The materials used in construction of the seat shall also have successfully completed testing with regard to the flammability of materials used in the occupant compartments of motor vehicles as outlined in FMVSS 302, of which dictates the allowable burning rate of materials in the occupant compartments of motor vehicles.

SEAT BACK DRIVER

The driver's seat shall include a standard seat back incorporating the all belts to seat feature (ABTS). The seat back shall feature a contoured head rest.

SEAT MOUNTING DRIVER

The driver's seat shall be installed in an ergonomic position in relation to the cab dash.

SEAT OFFICER

The officer's seat shall be an H.O. Bostrom 300 Series Firefighter model seat. The seat shall feature two-way manual adjustment and shall include a tapered and padded seat cushion. The seat shall also feature integral springs to isolate shock.

The seat shall feature an all belts to seat (ABTS) style of safety restraint. The ABTS feature shall include a three-point shoulder harness with the lap belt, automatic retractor and buckle as an integral part of the seat assembly.

The minimum vertical dimension from the seat H-point to the ceiling for this belted seating position shall be 35.00 inches.

This model of seat shall have successfully completed the static load tests by FMVSS 207, 209, 210 and 302 in effect at the time of manufacture. This testing shall include a simultaneous forward load of 3000 pounds each on the lap and shoulder belts and twenty (20) times the weight through the center of gravity. The model of seats shall also have successfully completed the flammability of materials used in the occupant compartments of motor vehicles as outlined in FMVSS 302, of which decides the burning rate of materials in the occupant compartments of motor vehicles.

SEAT BACK OFFICER

The officer's seat shall include a standard seat back incorporating the all belts to seat feature (ABTS). The seat back shall feature a contoured head rest.

SEAT MOUNTING OFFICER

The officer's seat shall be installed in an ergonomic position in relation to the cab dash.

POWER SEAT WIRING

The power seat or seats installed in the cab shall be wired directly to battery power.

SEAT BELT ORIENTATION CREW

The crew position seat belts shall follow the standard orientation which extends from the outboard shoulder extending to the inboard hip.

SEAT REAR FACING OUTER LOCATION

The crew area shall include two (2) rear facing crew seats, which include one (1) located directly behind the left side front seat and one (1) located directly behind the right side front seat.

SEAT CREW REAR FACING OUTER

The crew area shall include a seat in the rear facing outer position which shall be a H.O. Bostrom 300 Series Firefighter model seat. The seat shall feature a tapered and padded seat, and cushion. The seat and cushion shall be hinged and compact in design for additional room and shall remain in the stored position until occupied.

The seat shall feature an all belts to seat (ABTS) style of safety restraint. The ABTS feature shall include a three-point shoulder harness with the lap belt and automatic retractor as an integral part of the seat assembly. The buckle portion of the seat belt shall be mounted on a rigid or semi-rigid stalk such that the buckle remains positioned within easy reach of the occupant.

The minimum vertical dimension from the seat H-point to the ceiling for each belted seating position shall be 35.00 inches.

This model of seat shall have successfully completed the static load tests by FMVSS 207/210. This testing shall include a simultaneous forward load of 3000 pounds each on the lap and shoulder belts and twenty (20) times the weight through the center of gravity. This model of seat installed in the cab model, as specified, shall have successfully completed the dynamic sled testing using FMVSS 208 as a guide with the following accommodations. In order to reflect the larger size outfitted firefighters, the test dummy used shall be a 95th percentile hybrid III male weighing 225 pounds rather than the 50th percentile male dummy weighing 165 pounds as referenced in FMVSS 208. The model of seats shall also have successfully completed the flammability of materials used in the occupant compartments of motor vehicles as outlined in FMVSS 302, of which decides the burning rate of materials in the occupant compartments of motor vehicles.

SEAT BACK REAR FACING OUTER

The rear facing outboard seat shall feature a Bostrom SecureAll™ self contained breathing apparatus (SCBA) locking system which shall store most U.S. and International SCBA brands and bottle sizes while in transit or for storage within the seat back. The bracket shall be easily adjustable for all SCBA brands and cylinder diameters. All adjustment points shall utilize similar hardware and adjustments shall be made with one tool.

The bracket shall be adjustable to compensate for different cylinder lengths without the use of tools. The adjustment shall be made by raising a lever and moving the top clamp vertically.

The bracket system shall be free of straps that may interfere with auxiliary equipment on SCBA units. The center guide fork shall keep the SCBA tank in place for a safe and comfortable fit in the seat back cavity. The SCBA unit simply needs to be pushed against the pivot arm to engage the patented auto-locking system. Once the lock is engaged, the top clamp shall surround the top of the SCBA tank for a secure fit in all directions.

The SecureAll™ shall include a release handle which shall be integrated into the center of the bottom seat cushion for easy access and to eliminate hooking the release handle with clothing or other equipment.

The seat back shall include a removable padded cover which shall be provided over the SCBA cavity.

SEAT MOUNTING REAR FACING OUTER

The rear facing outer seats shall offer special mounting positions which shall be 2.00 inches towards the rear wall offering additional space between the front seats and the outer rear facing seats.

SEAT FORWARD FACING CENTER LOCATION

The crew area shall include two (2) forward facing center crew seats with both located at the center of the rear wall.

SEAT CREW FORWARD FACING CENTER

The crew area shall include a seat in the forward facing center position which shall be a H.O. Bostrom 300 Series Firefighter model seat. The seat shall feature a tapered and padded seat, and cushion. The seat and cushion shall be hinged and compact in design for additional room and shall remain in the stored position until occupied.

The seat shall feature an all belts to seat (ABTS) style of safety restraint. The ABTS feature shall include a three-point shoulder harness with the lap belt and automatic retractor as an integral part of the seat assembly. The buckle portion of the seat belt shall extend from the seat base towards the driver position within easy reach of the occupant.

The minimum vertical dimension from the seat H-point to the ceiling for each belted seating position shall be 35.00 inches.

This model of seat shall have successfully completed the static load tests by FMVSS 207/210. This testing shall include a simultaneous forward load of 3000 pounds each on the lap and shoulder belts and twenty (20) times the weight through the center of gravity. This model of seat installed in the cab

model, as specified, shall have successfully completed the dynamic sled testing using FMVSS 208 as a guide with the following accommodations. In order to reflect the larger size outfitted firefighters, the test dummy used shall be a 95th percentile hybrid III male weighing 225 pounds rather than the 50th percentile male dummy weighing 165 pounds as referenced in FMVSS 208. The model of seats shall also have successfully completed the flammability of materials used in the occupant compartments of motor vehicles as outlined in FMVSS 302, of which decides the burning rate of materials in the occupant compartments of motor vehicles.

SEAT BACK FORWARD FACING CENTER

The forward facing center seat shall feature a SecureAll™ self contained breathing apparatus (SCBA) locking system which shall be one bracket model and store most U.S. and International SCBA brands and sizes while in transit or for storage within the seat back. The bracket shall be easily adjustable for all SCBA brands and cylinder diameters. All adjustment points shall utilize similar hardware and adjustments shall be made with one tool.

The bracket shall be adjustable to compensate for different cylinder lengths without the use of tools. The adjustment shall be made by raising a lever and moving the top clamp vertically.

The bracket system shall be free of straps and clamps that may interfere with auxiliary equipment on SCBA units. The center guide fork shall keep the SCBA tank in place for a safe and comfortable fit in the seat back cavity. The SCBA unit simply needs to be pushed against the pivot arm to engage the patented auto- locking system. Once the lock is engaged, the top clamp shall surround the top of the SCBA tank for a secure fit in all directions.

The SecureAll™ shall include a release handle which shall be integrated into the seat cushion for quick and easy release. This shall eliminate the need for straps or pull cords to interfere with other SCBA equipment.

The seat back shall include a removable padded cover which shall be provided over the SCBA cavity.

SEAT FRAME FORWARD FACING

The forward facing center seating positions shall include an enclosed seat frame located and installed on the rear wall. The seat frame shall measure 42.38 inches wide X 12.38 inches high X 22.00 inches deep. The seat frame shall be constructed of Marine Grade 5052-H32 0.19 inch thick aluminum plate. The seat box shall be painted with the same color as the remaining interior.

SEAT FRAME FORWARD FACING STORAGE ACCESS

There shall be two (2) access points on the side of the storage area, one (1) on the driver side and one (1) on the officer side.

SEAT MOUNTING FORWARD FACING CENTER

The forward facing center seats shall be installed facing the front of the cab.

WINDSHIELD WIPER SYSTEM

The cab shall include a triple arm linkage wiper system which shall clear the windshield of water, ice and debris. There shall be two (2) windshield wipers; each shall be affixed to a radial arm. The wiper motor shall be activated by an intermittent wiper control located within easy reach of the driver's position.

ELECTRONIC WINDSHIELD FLUID LEVEL INDICATOR

The windshield washer fluid level shall be monitored electronically. When the washer fluid level becomes low the yellow "Check Message Center" indicator light on the instrument panel shall illuminate and the message center in the dual air pressure gauge shall display a "Check Washer Fluid Level" message.

CAB DOOR HARDWARE

The cab entry doors shall be equipped with exterior pull handles, suitable for use while wearing firefighter gloves. The handles shall be made of a fiber reinforced plastic composite with a black matt finish.

The interior exit door handles shall be flush paddle type with a black finish, which are incorporated into the upper door panel.

All cab entry doors shall include locks which are keyed alike. The door locks shall be designed to prevent accidental lockout.

DOOR LOCKS

The cab entry doors shall include a Controller Area Network (CAN) based electronic door lock system which shall include two (2) external keypads, one (1) located on the left side next to the front grab handle and one (1) on the right side next to the front grab handle. There shall be one (1) red rocker switch provided on the inside of each front cab entry door to actuate the cab door locks. Each door lock may also be manually actuated from the inside of the cab by means of a red knob located on the paddle handle of the respective door. The electronic door lock system shall include four (4) key fobs for actuation with buttons for cab entry door locks and for compartment door locks.

When the doors are unlocked using the external keypad or the key fobs the interior dome lights shall illuminate and remain on for a period of twenty (20) seconds. The interior dome safety feature shall require the interior lighting power to be battery direct.

Wiring shall also be provided for up to four (4) exterior cab compartments and up to four (4) body compartments.

POWER DOOR LOCK COMPARTMENT ACTIVATION

The power door lock feature shall include activation for exterior compartment door locks through the key fob and keypads.

GRAB HANDLES

The cab shall include one (1) 18.00 inch knurled, anti-slip, one-piece exterior assist handle behind each cab door. The grab handle shall be made of SAE 304 stainless steel and be 1.25 inch diameter to enable non-slip assistance with a gloved hand.

REARVIEW MIRRORS

Retrac Aerodynamic West Coast style dual vision mirror heads model 613305 shall be provided and installed on each of the front cab doors.

The mirrors shall be mounted via 1.00 inch diameter tubular stainless steel arms to provide a rigid mounting to reduce mirror vibration.

The mirrors shall measure 8.00 inches wide X 19.00 inches high and shall include an integral convex mirrors installed in the mirror head below the flat glass to provide a wider field of vision. The flat and convex mirrors shall be motorized with remote horizontal and vertical adjustment. The control switches shall be mounted within easy reach of the driver. The flat and convex mirrors shall be heated for defrosting in severe cold weather conditions.

The mirrors shall be constructed of a vacuum formed chrome plated ABS plastic housing that is corrosion resistant and shall include the finest quality non-glare glass.

REARVIEW MIRROR HEAT SWITCH

The heat for the rearview mirrors shall be controlled through a rocker switch on the dash in the switch panel.

CAB FENDER

Full width wheel well liners shall be installed on the extruded cab to limit road splash and enable easier cleaning. Fender shall consist of an inner liner 16.00 inches wide made of ABS composite and an outer fenderette 3.50 inches wide made of polished aluminum.

CAB EXTERIOR FRONT & SIDE EMBLEMS

The cab shall include one (1) Spartan emblem installed on the front air intake grille.

IGNITION

A master battery system with a keyless start ignition system shall be provided. Each system shall be controlled by a one-quarter turn Cole Hersee switch, both of which shall be mounted to the left of the steering wheel on the dash. A chrome push type starter button shall be provided adjacent to the master battery and ignition switches.

Each switch shall illuminate a green LED indicator light on the dash when the respective switch is placed in the "ON" position.

The starter button shall only operate when both the master battery and ignition switches are in the "ON" position.

BATTERY

The single start electrical system shall include three (3) Harris BCI 31 925 CCA batteries with a 210 minute reserve capacity and 4/0 welding type dual path starter cables per SAE J541.

BATTERY TRAY

The batteries shall be installed on a steel battery tray located on the left side of the chassis, securely bolted to the frame rails. The battery tray shall be coated with the same material as the frame.

The battery tray shall include drain holes in the bottom for sufficient drainage of water. A durable, non-conducting, interlocking mat made by Dri-Dek shall be installed in the bottom of the tray to allow for air flow and help prevent moisture build up. The batteries shall be held in place by non-conducting phenolic resin hold down boards.

BATTERY BOX COVER

The battery box shall include a steel cover which protects the top of the batteries on the left hand side of the vehicle. The cover shall include flush latches which shall keep the cover secure as well as a black powder coated handle for convenience when opening.

BATTERY CABLE

The starting system shall include cables which shall be protected by 275 degree F. minimum high temperature flame retardant loom, sealed at the ends with heat shrink and sealant.

The battery terminals shall not be utilized for auxiliary connections. The only acceptable auxiliary connections shall be for the cross over link from the left bank to the right bank, power for jumper studs and starter cables. All other auxiliary connections will use remote studs mounted in the battery box area. There shall be four (4) remote studs labeled as Common Power, Common Ground, Clean Power, and Clean Ground.

BATTERY JUMPER STUD

The starting system shall include battery jumper studs. These studs shall be located in the forward most portion of the driver's side lower step, 8.00 inches apart. The studs shall allow the vehicle to be jump started, charged, or the cab to be raised in an emergency in the event of battery failure.

ALTERNATOR

The charging system shall include a 320 amp Leece-Neville 12 volt alternator. The alternator shall include a self-exciting integral regulator.

STARTER MOTOR

The single start electrical system shall include a Delco brand starter motor.

BATTERY CONDITIONER

A Kussmaul Auto Charge 40 LPC battery conditioner shall be supplied. The battery conditioner shall provide a 40 amp output for the chassis batteries and a 15 amp output circuit for accessory loads. The battery conditioner shall be mounted in the cab in the LH rear facing outer seating position.

BATTERY CONDITIONER DISPLAY

A Kussmaul battery conditioner display shall be supplied. The battery conditioner display shall be mounted in the cab, viewable through the cab mid side window behind the left front door.

ELECTRICAL INLET LOCATION

An electrical inlet shall be installed on the left hand side of cab over the wheel well.

ELECTRICAL INLET

A Kussmaul 20 amp super auto-eject electrical receptacle shall be supplied. It shall automatically eject the plug when the starter button is depressed.

A single item or an addition of multiple items must not exceed the rating of the electric inlet that it's connected to.

Amp Draw Reference List:

Kussmaul 40 LPC Charger - 5 Amps
Kussmaul 40/20 Charger - 8.5 Amps
Kussmaul 80 LPC Charger - 13 Amps
Kussmaul EV-40 - 6.2 Amps
Blue Sea P12 7532 - 7.5 Amps
Iota DLS-45/IQ4 - 11 Amps
1000W Engine Heater - 8.33 Amps
1500W Engine Heater - 12.5 Amps
120V Air Compressor - 4.2 Amps
120V Dometic HVAC - 15 Amps

ELECTRICAL INLET CONNECTION

The electrical inlet shall be connected to the battery conditioner.

ELECTRICAL INLET COLOR

The electrical inlet connection shall include a yellow cover.

HEADLIGHTS

The cab front shall include four (4) rectangular LED headlamps with separate high and low beams mounted in bright chrome bezels. Each lamp shall include a heating system that de-ices the headlight.

FRONT TURN SIGNALS

The front fascia shall include two (2) Whelen model 600 4.00 inches X 6.00 inches programmable amber LED turn signals which shall be installed in an outboard position within the front fascia chrome bezel.

HEADLIGHT LOCATION

The headlights shall be located on the front fascia of the cab directly below the front warning lights.

SIDE TURN/MARKER LIGHTS

The sides of the cab shall include two (2) Tecniq S170 LED side marker lights which shall be provided just behind the front cab radius corners. The lights shall be amber with chrome bezels.

MARKER AND ICC LIGHTS

In accordance with FMVSS, there shall be five (5) marker lamps on the front of the vehicle designating identification and clearance. There shall be five (5) face mounted lights integrated into the scene light.

HEADLIGHT AND MARKER LIGHT ACTIVATION

The headlights and marker lights shall be controlled through a rocker switch within easy reach of the driver. There shall be a dimmer switch within easy reach of the driver to adjust the brightness of the dash lights. The headlamps shall be equipped with the "Daytime Running" light feature, which shall illuminate the headlights when the ignition switch is in the "On" position and the parking brake is released.

LIGHTBAR SWITCH

The light bar shall be controlled by a rocker switch located on the switch panel. This switch shall be clearly labeled for identification.

INTERIOR OVERHEAD LIGHTS

The cab shall include a LED dome lamp located over each door. The lights shall include push switches on each lamp to activate both the clear and red portions of the light individually.

INTERIOR OVERHEAD LIGHTS ACTIVATION

The clear portion of each lamp shall be activated by opening the respective door.

LIGHTBAR PROVISION

There shall be one (1) light bar installed on the cab roof. The light bar shall be provided and installed by the chassis manufacturer. The light bar installation shall include a lowered mounting that shall place the light bar just above the junction box and wiring to a control switch on the cab dash.

CAB FRONT LIGHTBAR

The lightbar provisions shall be for one (1) Whelen brand Freedom IV LED lightbar mounted centered on the front of the cab roof. The lightbar shall be 72.00 inches in length. The lightbar shall feature six (6) red LED light modules and two (2) clear LED light modules. The entire lightbar shall feature a clear lens. The clear lights shall be disabled with park brake engaged. The cable shall exit the lightbar on the right side of the cab.

FRONT SCENE LIGHTS

The front of the cab shall include one (1) HiViz model FireTech FT-B-72-ML-W LED scene light installed on the brow of the cab. The light shall feature (5) five integrated marker lights.

The housing shall be powder coated white.

FRONT SCENE LIGHT LOCATION

There shall be one (1) scene light mounted center on the front brow of the cab.

FRONT SCENE LIGHTS ACTIVATION

The front scene lighting shall be activated by individual rocker switches for each of the three (3) separate scene lighting circuits. Each circuit shall be activated independently and shall include rocker switches labeled “Front Scene”, “Front Flood”, and “Front Spotlight”.

SIDE SCENE LIGHTS

The side of the cab shall include two (2) Whelen 900 series 9SC0ENZR model scene lights, one (1) each side which shall be surface mounted with a chrome bezel. The Whelen lights shall offer LED lighting at a gradient 32-degree angle.

SIDE SCENE LIGHT LOCATION

The scene lighting located on the left and right sides of the cab shall be mounted rearward of the cab “B” pillar in the 10.00 inch raised roof portion of the cab between the front and rear crew doors.

SIDE SCENE ACTIVATION

The scene lights shall be activated by two (2) rocker switches located in the switch panel, one (1) for each light, and by opening the respective side cab doors.

GROUND LIGHTS

Each door shall include a Tecniq T44 LED ground light mounted to the underside of the cab step below each door. The lights shall include a polycarbonate lens, a housing which is vibration welded and LEDs which shall be shock mounted for extended life.

GROUND LIGHTS

The ground lighting shall be activated when the parking brake is set.

LOWER CAB STEP LIGHTS

The middle step located at each door shall include a Tecniq T44 LED light which shall activate with the opening of the respective door. The lights shall include a polycarbonate lens, a housing which is vibration welded and LEDs which shall be shock mounted for extended life.

INTERMEDIATE STEP LIGHTS

The intermediate step well area at the front doors shall include a TecNiq D06 LED light within a chrome housing. The front egress step lights shall provide visibility to the step well area for the first step exiting the vehicle. The Egress step lights shall activate with entry step lighting.

ENGINE COMPARTMENT LIGHT

There shall be a LED NFPA compliant light mounted under the engine tunnel for area work lighting on the engine. The light shall include a polycarbonate lens, a housing which is vibration welded and a bulb which shall be shock mounted for extended life. The light shall activate automatically when the cab is tilted.

DO NOT MOVE APPARATUS LIGHT

The front headliner of the cab shall include a flashing red TecNiq K50 LED light clearly labeled "Do Not Move Apparatus". In addition to the flashing red light, an audible alarm shall be included which shall sound while the light is activated.

The flashing red light shall be located centered left to right for greatest visibility.

The light and alarm shall be interlocked for activation when either a cab door is not firmly closed, or an apparatus compartment door is not closed, and the parking brake is released.

MASTER WARNING SWITCH

A master switch shall be included in the main rocker switch panel. The switch shall be a rocker type, red in color and labeled "Master" for identification. The switch shall feature control over all devices wired through it. Any warning device switch left in the "ON" position shall automatically power up when the master switch is activated.

INBOARD FRONT WARNING LIGHTS

The cab front fascia shall include two (2) Whelen 600 series Super LED front warning lights in the left and right inboard positions. The lights shall feature multiple flash patterns including steady burn for solid colors and multiple flash patterns for split colors. The lights shall be mounted to the front fascia of the cab within a chrome bezel.

INBOARD FRONT WARNING LIGHTS COLOR

The warning lights mounted on the cab front fascia in the inboard positions shall be red.

FRONT WARNING SWITCH

The front warning lights shall be controlled via rocker switch on the panel. This switch shall be clearly labeled for identification.

INTERSECTION WARNING LIGHTS

The chassis shall include two (2) Whelen 600 series Super LED intersection warning lights, one (1) each side. The lights shall feature multiple flash patterns including steady burn for solid colors and multiple flash patterns for split colors.

INTERSECTION WARNING LIGHTS COLOR

The intersection lights shall be red.

INTERSECTION WARNING LIGHTS LOCATION

The intersection lights shall be mounted on the side of the bumper in the rearward position.

SIDE AND INTERSECTOR WARNING SWITCH

The side and intersector warning lights shall be controlled by a rocker switch on the switch panel. This switch shall be clearly labeled for identification.

SIREN CONTROL HEAD

A Whelen 295HFS2 electronic siren control head with remote amplifier shall be provided and flush mounted in the switch panel with a location specific to the customer's needs. The siren shall feature 200-watt output, hands free mode and shall be in "standby" mode awaiting instruction. The siren shall offer radio broadcast, public address, wail, yelp, or piercer tones and hands free operation which shall allow the operator to turn the siren on and off from the horn ring if a horn/siren selector switch option is also selected.

AUDIBLE WARNING LH FOOT SWITCH

Two (2) foot actuated switches shall be supplied for installation in the front section of the cab for driver actuation. One (1) switch shall be wired to actuate the air horn(s) and one (1) switch the mechanical siren(s).

AIR HORN FOOT SWITCH LH

The air horn foot switch shall be a Linemaster model 491-S.

AIR HORN FOOT SWITCH LH LOCATION

The air horn foot switch shall be located on the left hand side accessible to the driver between the steering column and the door.

AIR HORN FOOT SWITCH LH POSITION

The air horn foot switch shall be positioned inboard of any other foot switch, if applicable.

MECHANICAL SIREN FOOT SWITCH LH

The mechanical siren foot switch shall be a Linemaster model 491-S.

MECHANICAL SIREN FOOT SWITCH LH LOCATION

The mechanical siren foot switch shall be located on the left hand side accessible to the driver between the steering column and the door.

MECHANICAL SIREN FOOT SWITCH LH POSITION

The mechanical siren foot switch shall be positioned outboard of any other foot switch, if applicable.

AUDIBLE WARNING LH FOOT SWITCH BRACKET

A 30.00 degree angled foot switch bracket, wide enough to accommodate (2) foot switches, shall be installed outboard of the steering column for specified driver accessible foot switch activations.

AIR HORN AUXILIARY ACTIVATION

The air horn activation shall be accomplished by a black momentary push button on the switch panel. An air horn activation circuit shall be provided to the chassis harness pump panel harness connector.

MECHANICAL SIREN BRAKE/AUXILIARY ACTIVATION

The mechanical siren shall be actuated by a black push button in the switch panel on the dash. A red push button siren brake control shall be provided in the switch panel on the dash.

MECHANICAL SIREN INTERLOCK

The siren shall only be active when master warning switch is on to prevent accidental engagement.

BACK-UP ALARM

An ECCO model 575 backup alarm shall be installed at the rear of the chassis with an output level of 107 dB. The alarm shall automatically activate when the transmission is placed in reverse.

INSTRUMENTATION

An ergonomically designed instrument panel shall be provided. Each gauge shall be backlit with LED lamps. Stepper motor movements shall drive all gauges. The instrumentation system shall be multiplexed and shall receive ABS, engine, and transmission information over the J1939 data bus to reduce redundant sensors and wiring.

A twenty eight (28) icon lightbar message center with integral LCD odometer/trip odometer shall be included. The odometer shall display up to 999,999.9 miles. The trip odometer shall display 9,999.9 miles. The LCD message center screen shall be capable of custom configuration by the users for displaying certain vehicle status and diagnostic functions.

The instrument panel shall contain the following gauges:

One (1) three-movement gauge displaying vehicle speed, fuel level, and Diesel Exhaust Fluid (DEF) level. The primary scale on the speedometer shall read from 0 to 100 MPH, and the secondary scale on the speedometer shall read from 0 to 160 KM/H. The scale on the fuel and DEF level gauges shall read from empty to full as a fraction of full tank capacity. Red indicator lights in the gauge and an audible alarm shall indicate low fuel or low DEF at 1/8th tank level.

One (1) three-movement gauge displaying engine RPM, and primary and secondary air system pressures shall be included. The scale on the tachometer shall read from 0 to 3000 RPM. The scale on the air pressure gauges shall read from 0 to 150 pounds per square inch (PSI) with a red line zone indicating critical levels of air pressure. Red indicator lights in the gauge and an audible alarm shall indicate low air pressure.

One (1) four-movement gauge displaying engine oil pressure, coolant temperature, voltmeter, and transmission temperature shall be included. The scale on the engine oil pressure gauge shall read from 0 to 100 pounds PSI with a red line zone indicating critical levels of oil pressure. A red indicator light in the gauge and audible alarm shall indicate low engine oil pressure. The scale on the coolant temperature gauge shall read from 100 to 250 degrees Fahrenheit (°F) with a red line zone indicating critical coolant temperatures. A red indicator light in the gauge and audible alarm shall indicate high coolant temperature. The scale on the voltmeter shall read from 9 to 18 volts with a red line zone indicating critical levels of battery voltage. A red indicator light in the gauge and an audible alarm shall indicate high or low system voltage. The low voltage alarm shall indicate when the system voltage has dropped below 11.8 volts for more than 120 seconds in accordance with the requirements of NFPA 1901. The scale on the transmission temperature gauge shall read from 100 to 300 degrees °F with a red line zone indicating critical temperatures. A red indicator light in the gauge and an audible alarm shall indicate a high transmission temperature.

The light bar portion of the message center shall include twenty-eight (28) LED backlit indicators. The lightbar shall be split with fourteen (14) indicators on each side of the LCD message screen. The lightbar shall contain the following indicators and produce the following audible alarms when supplied in conjunction with applicable configurations:

RED INDICATORS

Stop Engine - indicates critical engine fault

Air Filter Restricted - indicates excessive engine air intake restriction

Park Brake - indicates parking brake is set

Seat Belt - indicates a seat is occupied and corresponding seat belt remains unfastened

Low Coolant - indicates critically low engine coolant

Cab Tilt Lock - indicates the cab tilt system locks are not engaged.

AMBER INDICATORS

Malfunction Indicator Lamp (MIL) - indicates an engine emission control system fault
Check Engine - indicates engine fault
Check Transmission - indicates transmission fault
Anti-Lock Brake System (ABS) - indicates anti-lock brake system fault
High exhaust system temperature – indicates elevated exhaust temperatures
Water in Fuel - indicates presence of water in fuel filter
Wait to Start - indicates active engine air preheat cycle
Windshield Washer Fluid – indicates washer fluid is low
DPF restriction - indicates a restriction of the diesel particulate filter
Regen Inhibit-indicates regeneration of the DPF has been inhibited by the operator
Range Inhibit - indicates a transmission operation is prevented and requested shift request may not occur.
SRS - indicates a problem in the supplemental restraint system
Check Message - indicates a vehicle status or diagnostic message on the LCD display requiring attention.

GREEN INDICATORS

Left and Right turn signal indicators
ATC - indicates low wheel traction for automatic traction control equipped vehicles, also indicates mud/snow mode is active for ATC system
High Idle - indicates engine high idle is active.
Cruise Control - indicates cruise control is enabled
OK to Pump - indicates the pump is engaged and conditions have been met for pump operations
Pump Engaged - indicates the pump transmission is currently in pump gear
Auxiliary Brake - indicates secondary braking device is active

BLUE INDICATORS

High Beam indicator

AUDIBLE ALARMS

Air Filter Restriction
Cab Tilt Lock
Check Engine
Check Transmission
Open Door/Compartment
High Coolant Temperature
High or Low System Voltage
High Transmission Temperature
Low Air Pressure
Low Coolant Level
Low DEF Level
Low Engine Oil Pressure
Low Fuel
Seatbelt Indicator
Stop Engine
Water in Fuel
Extended Left/Right Turn Signal On
ABS System Fault

BACKLIGHTING COLOR

The instrumentation gauges and the switch panel legends shall be backlit using red LED backlighting.

CAMERA REAR

One (1) Audiovox Voyager heavy duty box shaped HD camera shall be shipped loose for OEM installation in the body to afford the driver a clear view to the rear of the vehicle.

The camera system shall include a one-way communication device that shall be an integral part of the rear camera for the use of voice commands directly to the driver. The rear camera display shall activate when the vehicle's transmission is placed in reverse.

CAMERA DISPLAY

The camera system shall be wired to a 7.00 inch flip down HD monitor which shall include a color display and day and night brightness modes installed above the driver position.

COMMUNICATION ANTENNA

An antenna base, for use with an NMO type antenna, shall be mounted on the right hand front corner of the cab roof so not to interfere with light bars or other roof mounted equipment installed by chassis builder. The antenna base shall be an Antenex model MABVT8 made for either a 0.38 inch or 0.75 inch receiving hole in the antenna and shall include 17.00 foot of RG58 A/U cable with no connector at the radio end of the cable. The antenna base design provides the most corrosion resistance and best power transfer available from a high temper all brass construction and gold plated contact design. The antenna base shall be chassis builder supplied.

COMMUNICATION ANTENNA CABLE ROUTING

The antenna cable shall be routed from the antenna base mounted on the roof to the area inside the center rocker switch console.

AUXILIARY COMMUNICATION ANTENNA

An auxiliary antenna base, for use with and NMO type antenna, shall be installed on the cab. The antenna base shall be an Antenex model MABVT8 and shall include 17.00 foot of RG58 A/U cable with no connector at the radio end of the cable. The antenna base shall be mounted in the inboard position on the right hand front corner of the cab roof so not to interfere with light bars or other roof mounted equipment installed by chassis builder. The antenna base shall be chassis builder supplied.

AUXILIARY COMMUNICATION ANTENNA CABLE ROUTING

The auxiliary antenna cable shall be routed from the antenna base mounted on the roof to the area inside the center rocker switch console.

CAB EXTERIOR PROTECTION

The cab face shall have a removable plastic film installed over the painted surfaces to protect the paint finish during transport to the body manufacturer.

FIRE EXTINGUISHER

A 2.50 pound D.O.T approved fire extinguisher with BC rating shall be shipped loose with the cab.

DOOR KEYS

The cab and chassis shall include a total of four (4) door keys for the manual door locks.

WARRANTY

Purchaser shall receive a Custom Chassis One (1) Year or 18,000 Miles limited warranty in accordance with, and subject to, warranty certificate RFW0101. The warranty certificate is incorporated by reference into this proposal, and included with this proposal or available upon request.

CHASSIS OPERATION MANUAL

There shall be two (2) digital copies of the chassis operation manual provided with the chassis. The digital data shall include a parts list specific to the chassis model.

ENGINE AND TRANSMISSION OPERATION MANUALS

The following manuals specific to the engine and transmission models ordered will be included with the chassis in the ship loose items:

- (1) Hard copy of the Engine Operation and Maintenance manual with digital copy
- (1) Digital copy of the Transmission Operator's manual
- (1) Digital copy of the Engine Owner's manual

CAB/CHASSIS AS BUILT WIRING DIAGRAMS

The cab and chassis shall include two (2) digital copies of wiring schematics and option wiring diagrams.

SALES TERMS

The sale of the chassis shall be governed by the terms contained on the Sales Terms – Acceptance of Purchase Order document, a copy of which is attached to this option.

DRIVELINE LAYOUT CONFIRMATION

During the design phase of the chassis the Spartan Chassis driveline engineer shall submit the driveline layout to an OEM engineer to review the chassis design for any potential problems integrating the OEM body to the chassis. The OEM engineer shall provide approval to the driveline engineer prior to driveline bills of materials being released.