

CUSTOMER APPROVAL SIGNATURE:

DATE:

AFE-2542

IN THE EVENT THERE ARE DISCREPANCIES BETWEEN THE DRAWING AND THE SPECIFICATIONS, THE SPECIFICATIONS SHALL PREVAIL.

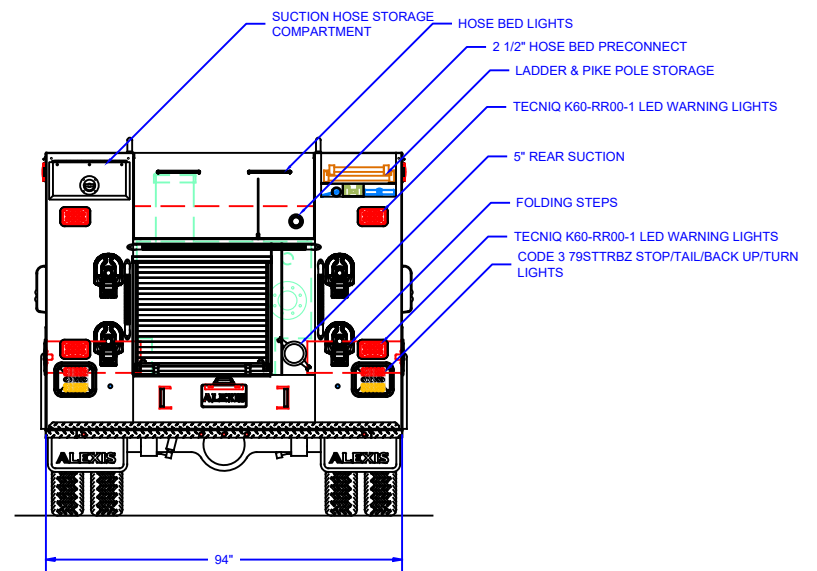
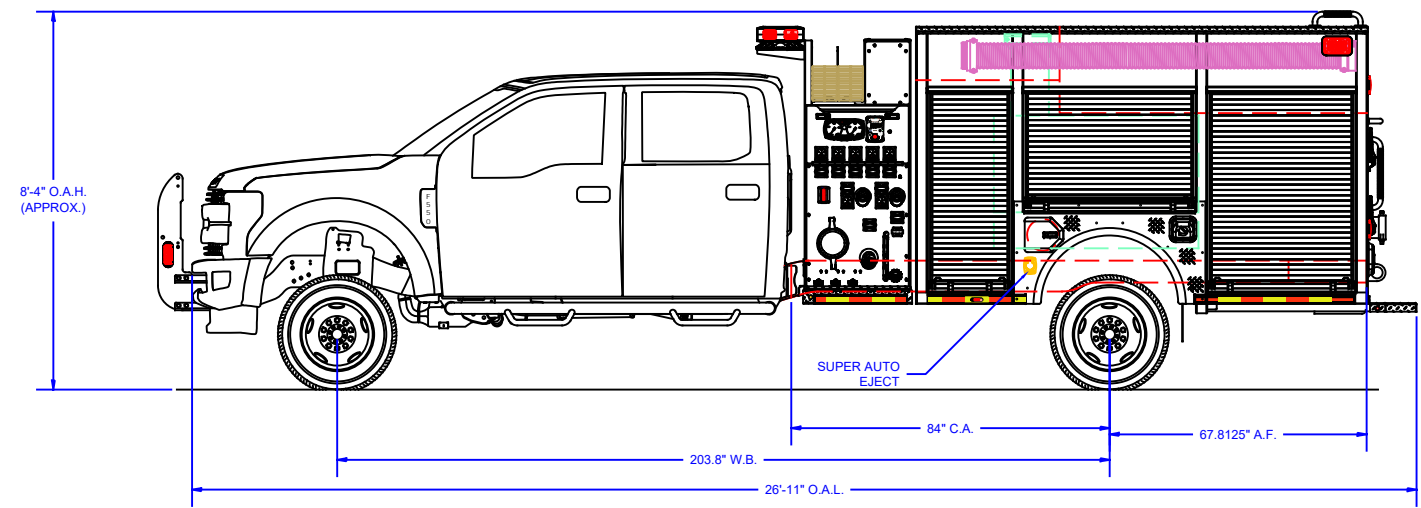
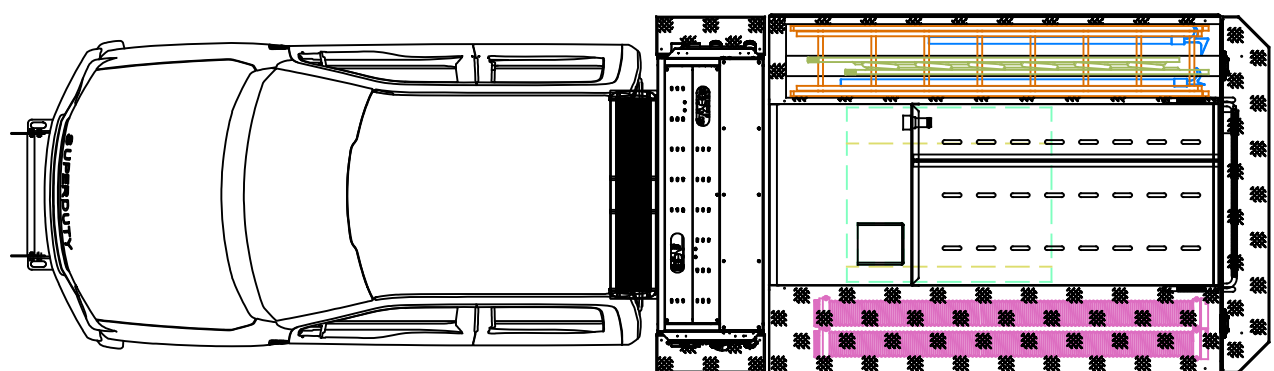
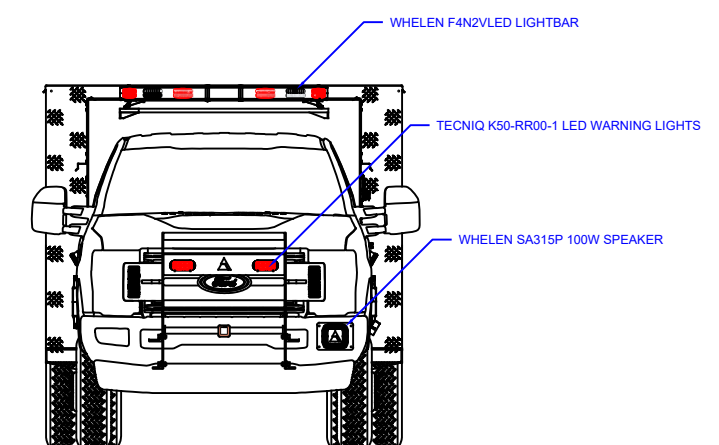
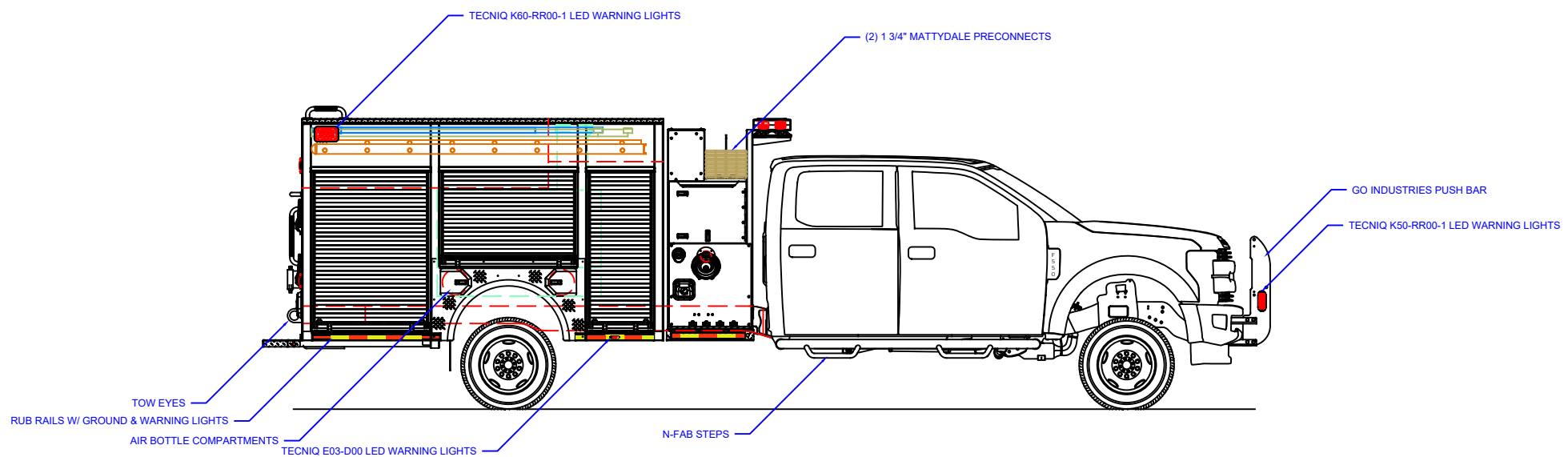

REVISION HISTORY				
REV	DESCRIPTION	DATE	DWN	
01	UPDATES	10/31/23	MLT	

Pump Info:	
Control Location: Side	Apparatus Type: Mini Pumper
Pump Drive: Split Shaft	Chassis: Ford 4-Door
Pump Make: Hale	Tank Capacity: 300
Pump Model: DSD	
Pump GPM: 1500	Material: Aluminum

COMPARTMENT DIMENSIONS	
COMP #	DOOR OPENING SIZES
L1 & R1	19" WIDE X 48" HIGH X 21" DEEP
L2 & R2	43" WIDE X 27" HIGH X 21" DEEP
L3 & R3	36" WIDE X 48" HIGH X 21" DEEP
REAR	34" WIDE X 25" HIGH X 41" DEEP

UNLESS OTHERWISE SPECIFIED DIMENSIONS ARE IN INCHES TOLERANCES ARE NOT CUMULATIVE
 DECIMAL ±0.062 ANGULAR ±0.5° FRACTIONAL ±1/16 METRIC ±1.6 mm
 The copyright of this drawing and design and the right of reproduction there is vested in and belongs to Alexis Fire Equipment Co.
 DRAWN M. TINKHAM 1/26/22
 MATERIAL

ALEXIS FIRE EQUIPMENT CO.
 P.O. BOX 549, ALEXIS, ILLINOIS 61412
MINI PUMPER
 ALEXIS FIRE EQUIPMENT CO.
 ALEXIS, IL
 DWG NO MP1-A17-2
 CONTRACT # 2542 SHEET 1 OF 2

CUSTOMER APPROVAL SIGNATURE:

DATE:

AFE-2542

IN THE EVENT THERE ARE DISCREPANCIES BETWEEN THE DRAWING AND THE SPECIFICATIONS, THE SPECIFICATIONS SHALL PREVAIL.

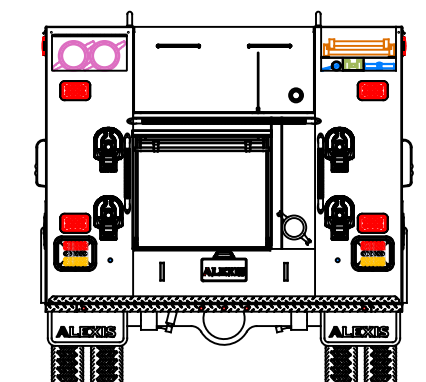
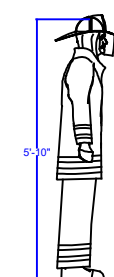
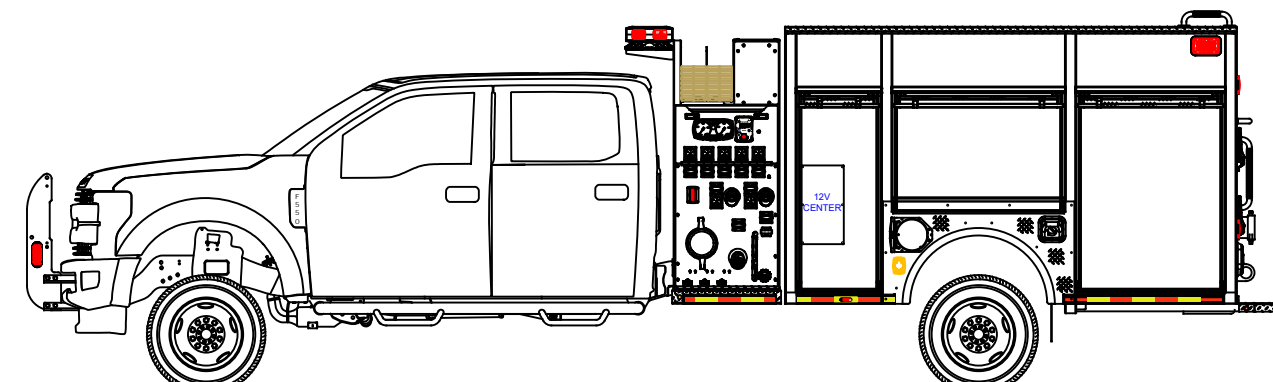
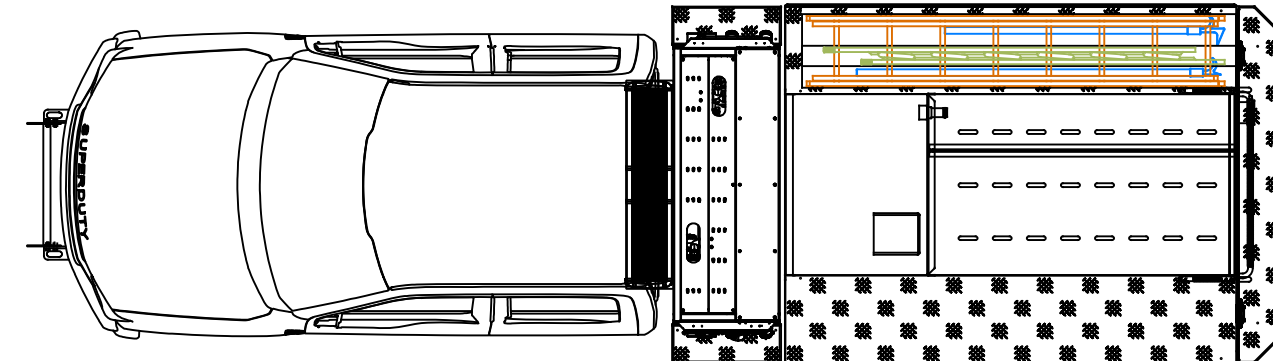
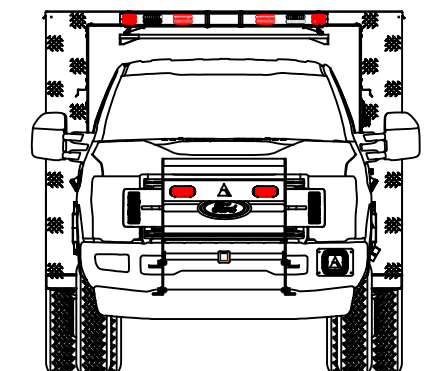
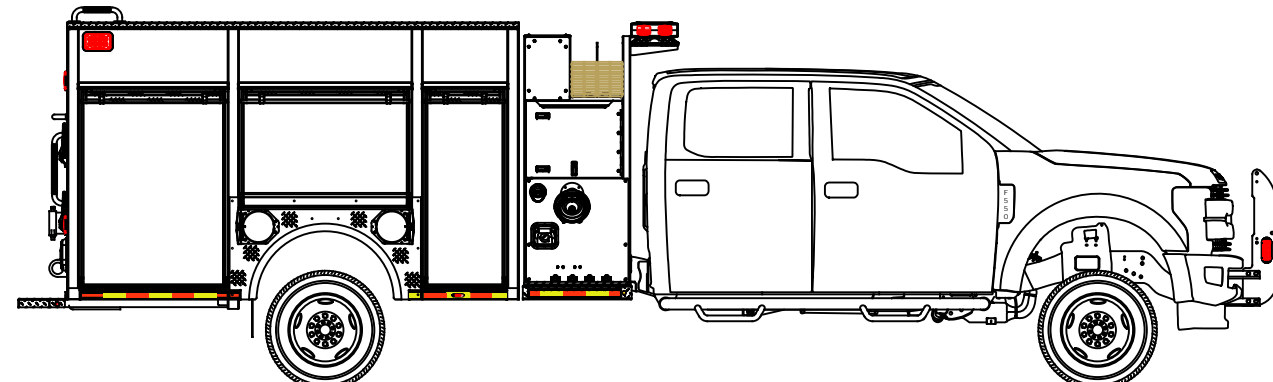

REVISION HISTORY				
REV	DESCRIPTION	DATE	DWN	
01	UPDATES	10/31/23	MLT	

Pump Info:	
Control Location: Side	Apparatus Type: Mini Pumper
Pump Drive: Split Shaft	Chassis: Ford 4-Door
Pump Make: Hale	Tank Capacity: 300
Pump Model: DSD	
Pump GPM: 1500	Material: Aluminum

COMPARTMENT DIMENSIONS	
COMP #	DOOR OPENING SIZES
L1 & R1	19" WIDE X 48" HIGH X 21" DEEP
L2 & R2	43" WIDE X 27" HIGH X 21" DEEP
L3 & R3	36" WIDE X 48" HIGH X 21" DEEP
REAR	34" WIDE X 25" HIGH X 41" DEEP

UNLESS OTHERWISE SPECIFIED
DIMENSIONS ARE IN INCHES
TOLERANCES ARE NOT CUMULATIVE

DECIMAL ± 0.062 ANGULAR $\pm 0.5^\circ$
FRACTIONAL $\pm 1/16$ METRIC ± 1.6 mm

The copyright of this drawing and design and the right of reproduction there is vested in and belongs to Alexis Fire Equipment Co.

DRAWN: M. TINKHAM 1/26/22
MATERIAL:

ALEXIS FIRE EQUIPMENT CO.
P.O. BOX 549, ALEXIS, ILLINOIS 61412

MINI PUMPER
ALEXIS FIRE EQUIPMENT CO.
ALEXIS, IL

SIZE: D SCALE: 1/2" = 1'
DWG NO: MP1-A17-2
CONTRACT #: 2542 SHEET 2 OF 2

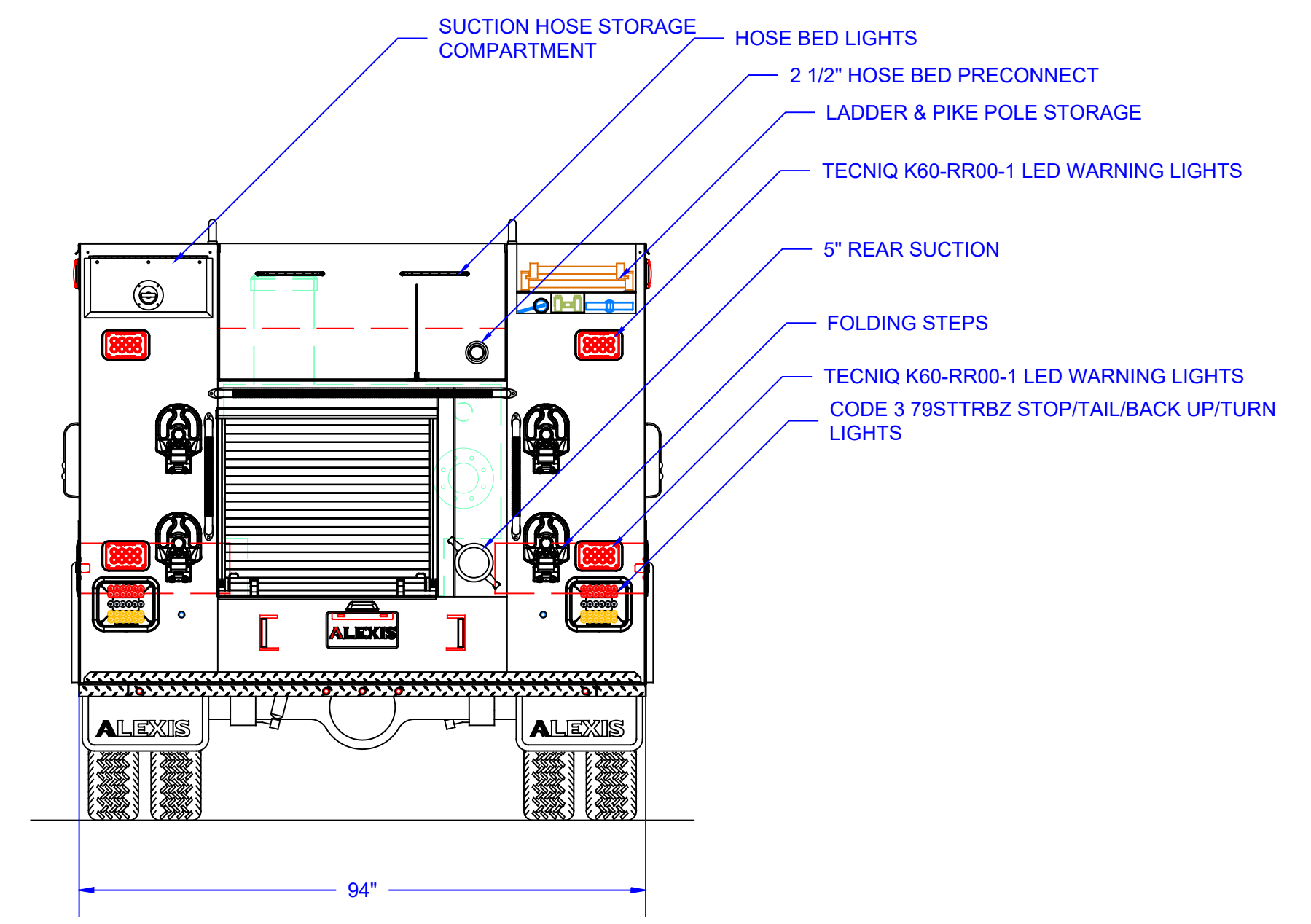
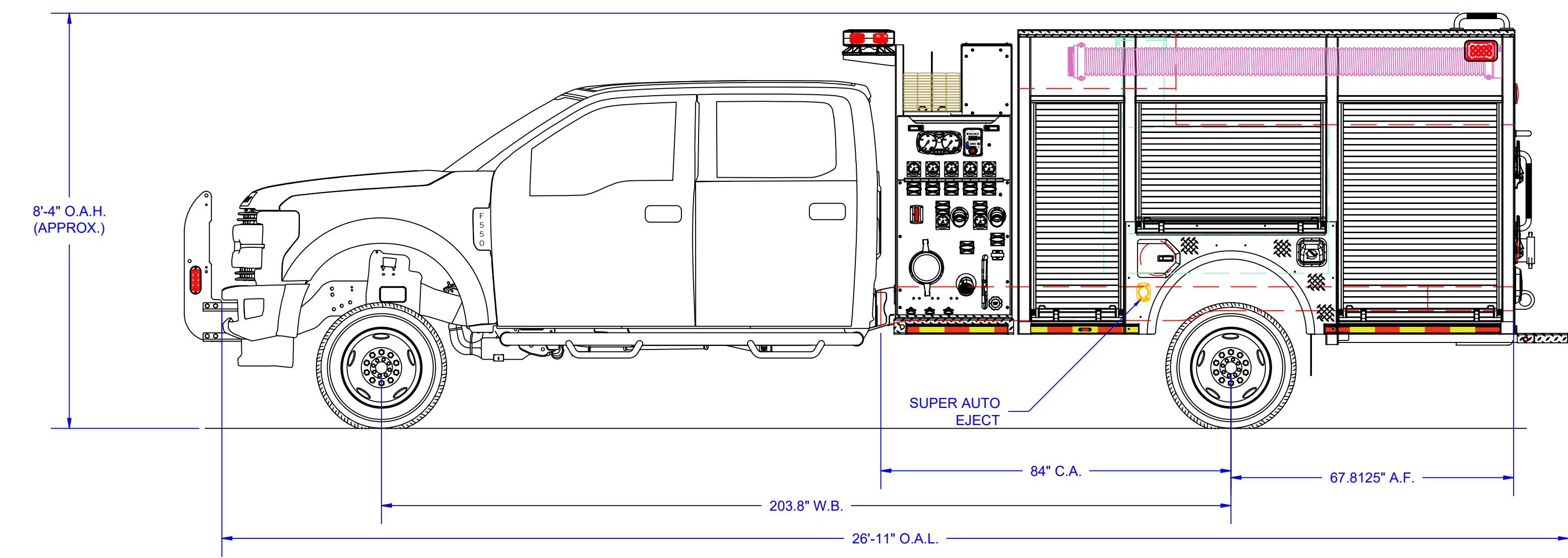
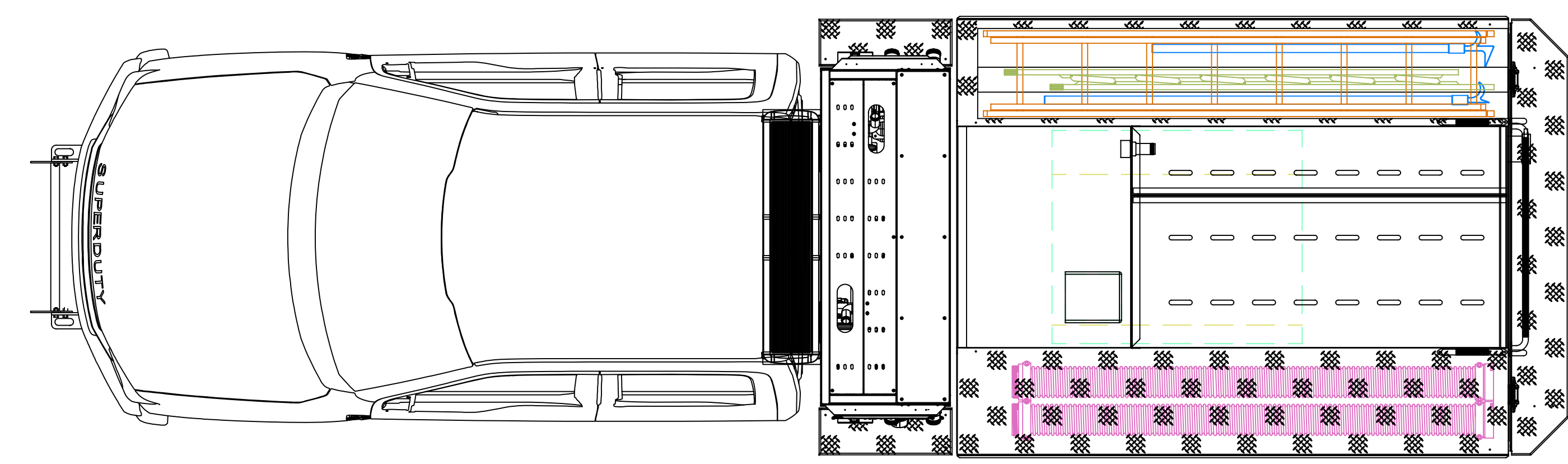
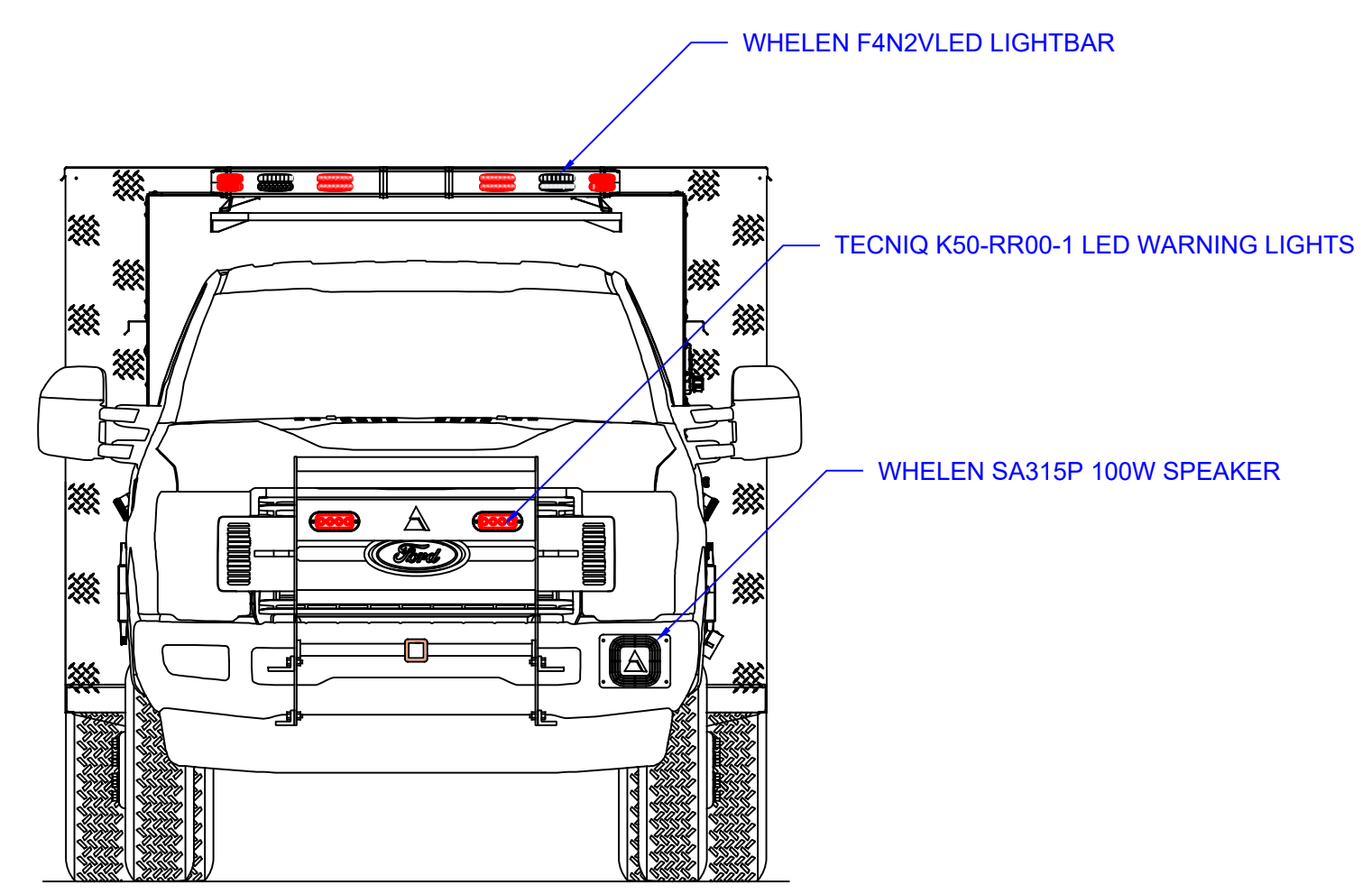
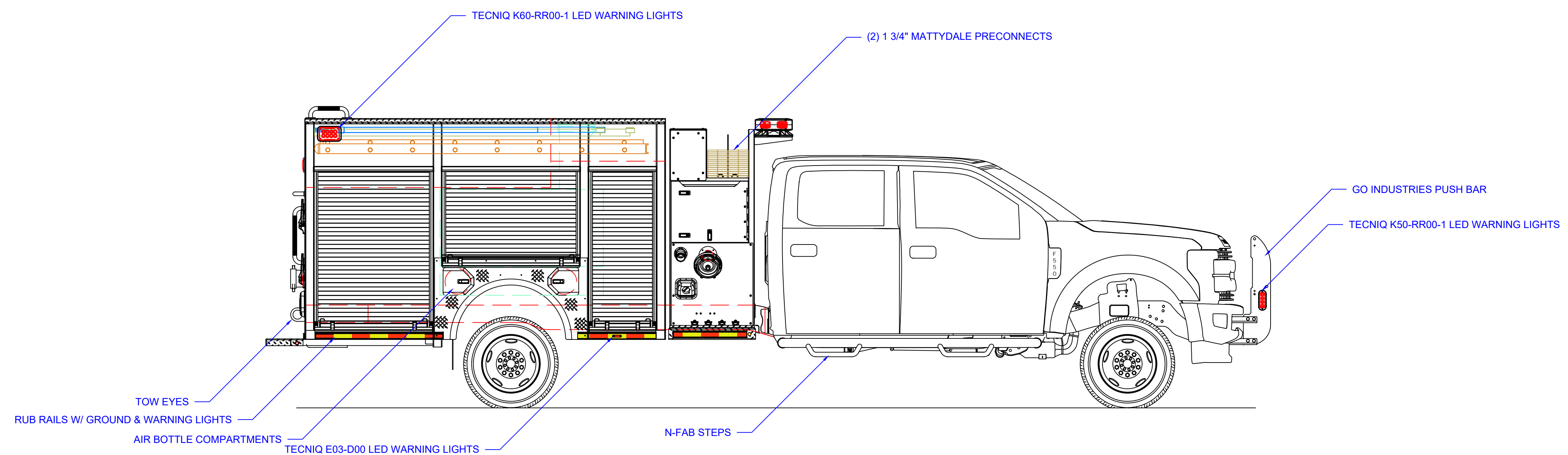

REVISION HISTORY				
REV	DESCRIPTION	DATE	DWN	
01	UPDATES	10/31/23	MLT	

Pump Info:		Apparatus Type: Mini Pumper
Control Location: Side	Pump Drive: Split Shaft	Chassis: Ford 4-Door
Pump Make: Hale	Pump Model: DSD	Tank Capacity: 300
Pump GPM: 1500	Material: Aluminum	

COMPARTMENT DIMENSIONS	
COMP #	DOOR OPENING SIZES
L1 & R1	19" WIDE X 48" HIGH X 21" DEEP
L2 & R2	43" WIDE X 27" HIGH X 21" DEEP
L3 & R3	36" WIDE X 48" HIGH X 21" DEEP
REAR	34" WIDE X 25" HIGH X 41" DEEP

UNLESS OTHERWISE SPECIFIED DIMENSIONS ARE IN INCHES TOLERANCES ARE NOT CUMULATIVE

DECIMAL ± 0.062 FRACTIONAL ± 1/16	ANGULAR ± 0.5° METRIC ± 1.6 mm	ALEXIS FIRE EQUIPMENT CO. P.O. BOX 549, ALEXIS, ILLINOIS 61412	MINI PUMPER ALEXIS FIRE EQUIPMENT CO. ALEXIS, IL														
<table border="1" style="width: 100%; border-collapse: collapse; font-size: x-small;"> <tr> <td style="width: 20%;">DRAWN</td> <td style="width: 20%;">M. TINKHAM</td> <td style="width: 20%;">DATE</td> <td style="width: 20%;">1/26/22</td> <td style="width: 20%;">SIZE</td> <td style="width: 20%;">SCALE</td> <td style="width: 20%;">DWG NO</td> </tr> <tr> <td>MATERIAL</td> <td></td> <td>CONTRACT #</td> <td>2542</td> <td>SHEET</td> <td>1 OF 2</td> <td style="text-align: center; font-weight: bold;">MP1-A17-2</td> </tr> </table>	DRAWN	M. TINKHAM	DATE	1/26/22	SIZE	SCALE	DWG NO	MATERIAL		CONTRACT #	2542	SHEET	1 OF 2	MP1-A17-2			
DRAWN	M. TINKHAM	DATE	1/26/22	SIZE	SCALE	DWG NO											
MATERIAL		CONTRACT #	2542	SHEET	1 OF 2	MP1-A17-2											

CUSTOMER APPROVAL SIGNATURE: _____

DATE: _____

AFE-2542
 IN THE EVENT THERE ARE DISCREPANCIES BETWEEN THE DRAWING AND THE SPECIFICATIONS, THE SPECIFICATIONS SHALL PREVAIL.

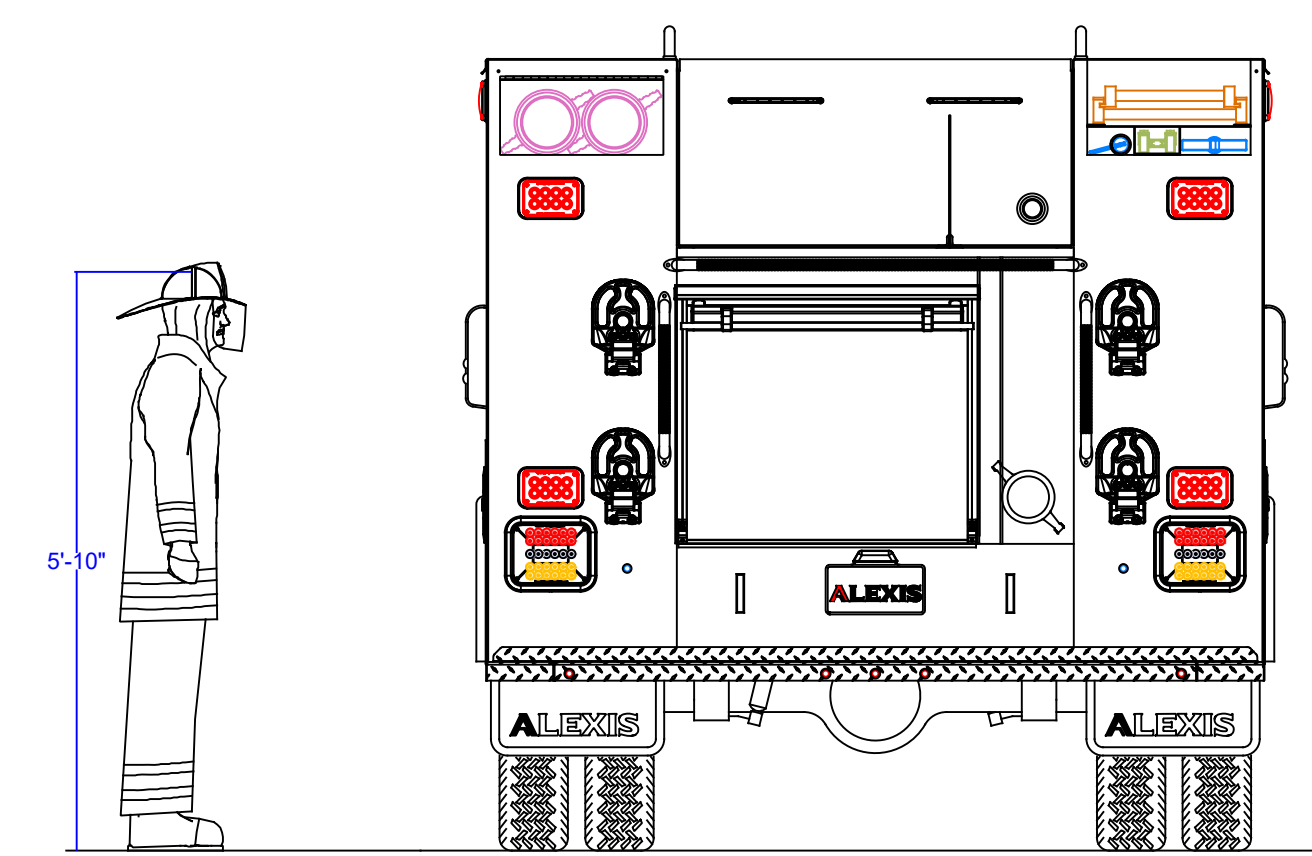
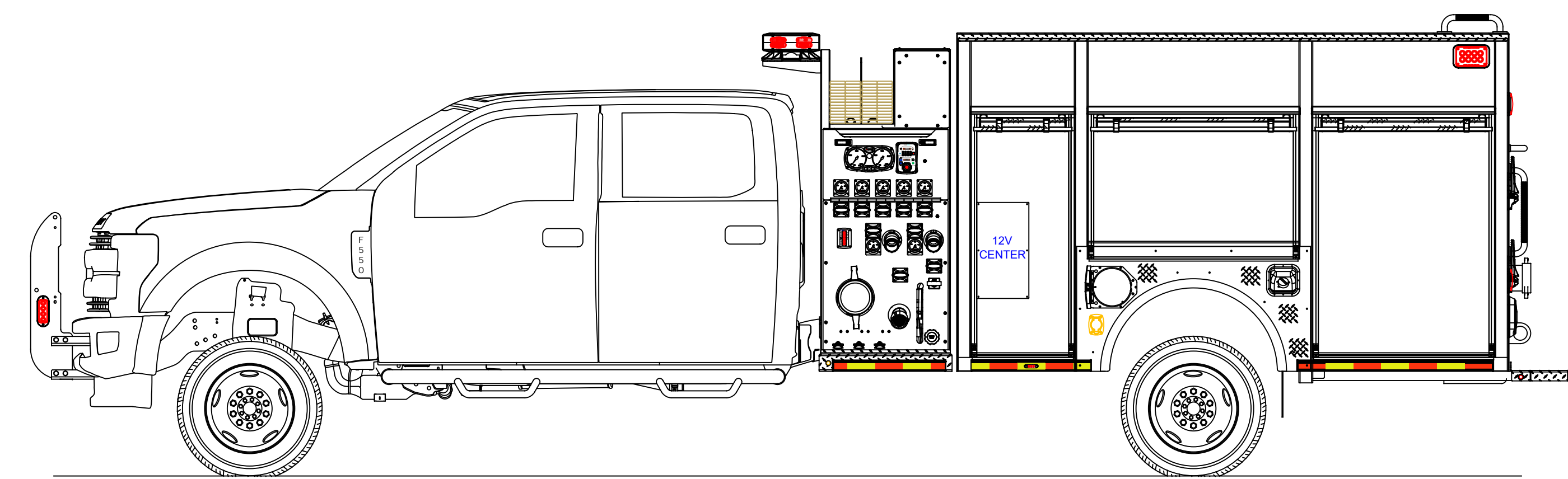
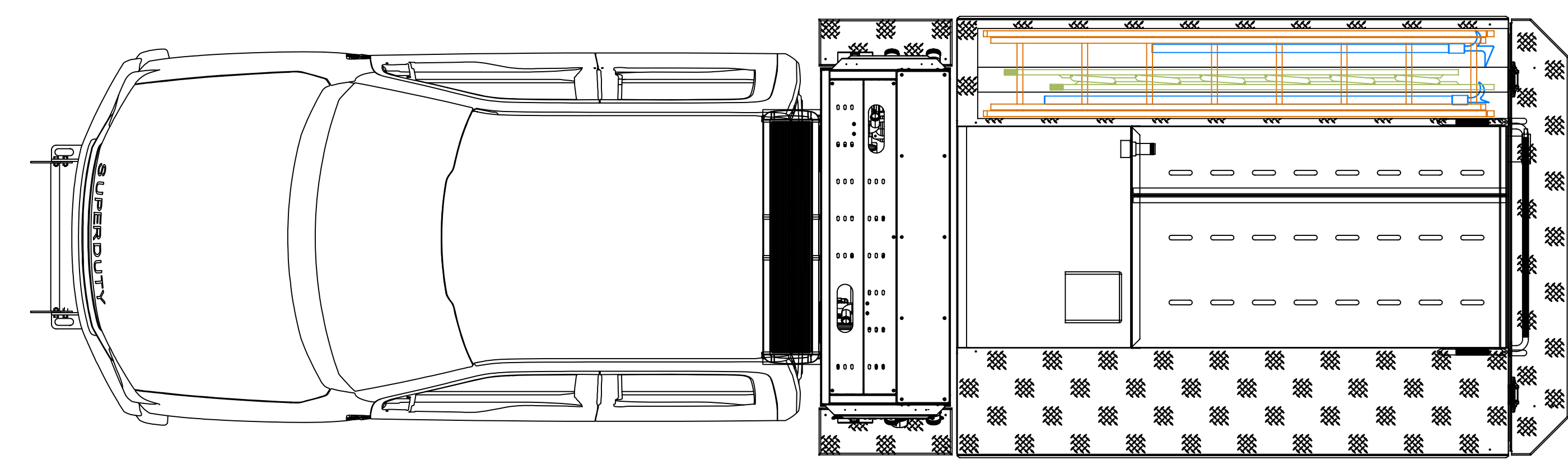
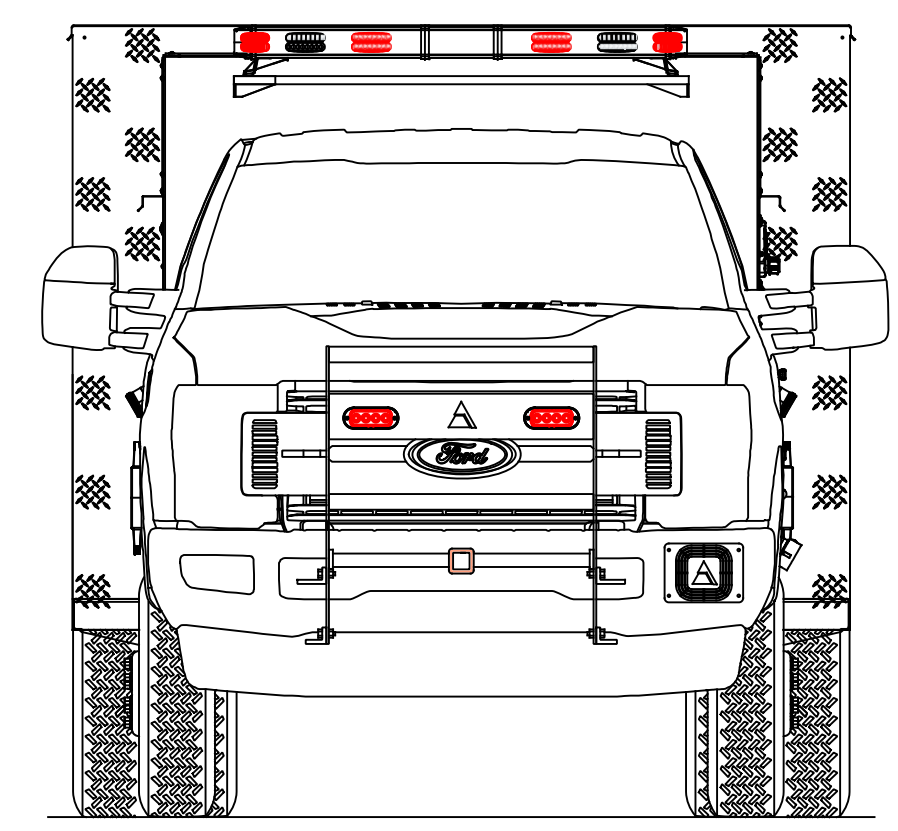
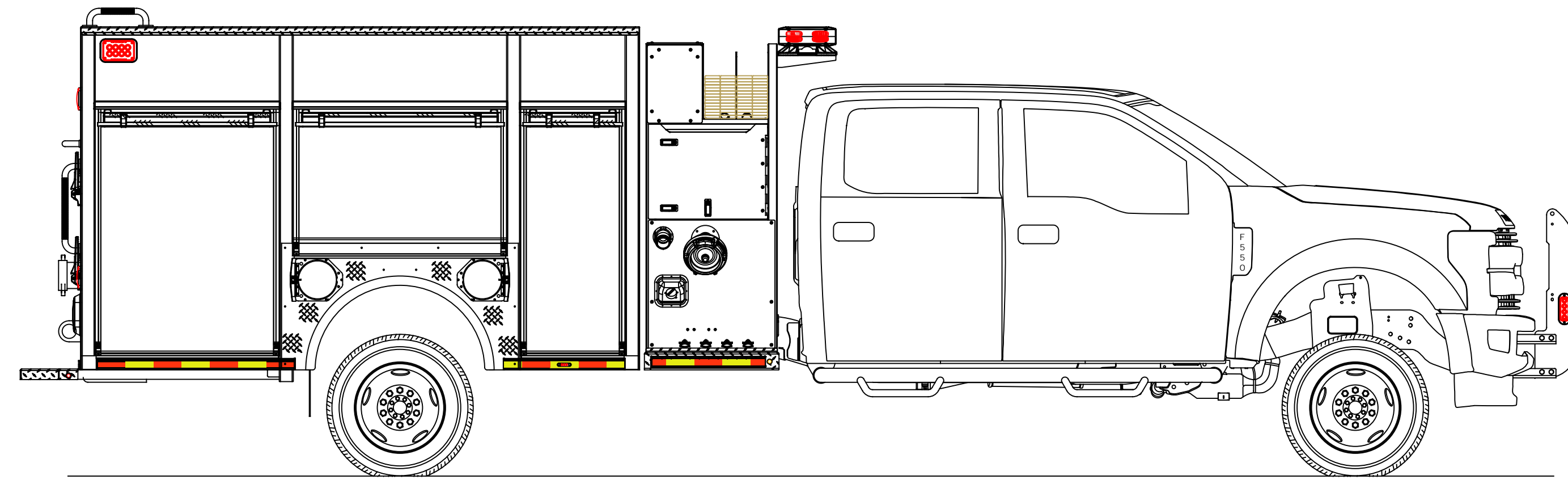

REVISION HISTORY			
REV	DESCRIPTION	DATE	DWN
01	UPDATES	10/31/23	MLT

Pump Info:	
Control Location: Side	Apparatus Type: Mini Pumper
Pump Drive: Split Shaft	Chassis: Ford 4-Door
Pump Make: Hale	Tank Capacity: 300
Pump Model: DSD	
Pump GPM: 1500	Material: Aluminum

COMPARTMENT DIMENSIONS	
COMP #	DOOR OPENING SIZES
L1 & R1	19" WIDE X 48" HIGH X 21" DEEP
L2 & R2	43" WIDE X 27" HIGH X 21" DEEP
L3 & R3	36" WIDE X 48" HIGH X 21" DEEP
REAR	34" WIDE X 25" HIGH X 41" DEEP

UNLESS OTHERWISE SPECIFIED DIMENSIONS ARE IN INCHES TOLERANCES ARE NOT CUMULATIVE
 DECIMAL ± 0.062 ANGULAR ± 0.5° FRACTIONAL ± 1/16 METRIC ± 1.6 mm

ALEXIS FIRE EQUIPMENT CO.
 P.O. BOX 549, ALEXIS, ILLINOIS 61412

MINI PUMPER
 ALEXIS FIRE EQUIPMENT CO.
 ALEXIS, IL

The copyright of this drawing and design and the right of reproduction there is vested in and belongs to Alexis Fire Equipment Co.

DRAWN	M. TINKHAM	DATE	1/26/22	SIZE	SCALE	DWG NO	MP1-A17-2
MATERIAL		CONTRACT #	2542	SHEET	2 OF 2		



 Alexis Fire Equipment
 109 East Broadway / Alexis, IL 61412
 800-322-2284  sales@alexisfire.com
 AlexisFire.com

Alexis Fire Equipment Company
Alexis, IL

We hereby propose to furnish, after your acceptance, approval, and proper execution of the accompanying contract, the fire apparatus as follows:

One (1) Alexis Demo #2542 Mini Pumper

As per specifications attached herewith.

TOTAL APPARATUS.....\$ *

* Does not include any applicable taxes. Any local or state tax, if applicable, must be added to the above price.

Shipment of completed apparatus shall be made within 550 calendar days after our approval of properly signed contract, subject to causes beyond our control. This proposal is made subject to your acceptance within thirty (30) days from date of same. If acceptance is delayed beyond that period, we will, upon request, advise you of any increase in said amount which may be occasioned by causes beyond our control.

Respectfully submitted,
ALEXIS FIRE EQUIPMENT COMPANY

By: _____

"QUALITY HAS NO SUBSTITUTE"



 Alexis Fire Equipment
109 East Broadway / Alexis, IL 61412
 800-322-2284  sales@alexisfire.com
 AlexisFire.com

PAYMENT TERMS

The chassis payment shall be made within ten (10) days of invoicing.

A progress payment of \$ shall be made within ten (10) days of invoicing, upon the initial construction of the apparatus body. The ___ Fire Department may **DEDUCT \$** from the front page price for this payment.

The balance of the contract plus any contract alterations shall be payable upon the delivery of the finished unit.

Upon payment, the Alexis Fire Equipment Company shall furnish the purchaser a "Statement of Origin" or the necessary validated documents required for title application.

Additional payment terms available upon request.



 Alexis Fire Equipment
109 East Broadway / Alexis, IL 61412
 800-322-2284  sales@alexisfire.com
 AlexisFire.com

ISO 9001:

Alexis Fire Equipment Company operates a Quality Management System under the requirements of ISO 9001. These standards, sponsored by the "International Organization for Standardization (ISO)," specify the quality systems that shall be established by the manufacturer for design, manufacture, installation and service.



 Alexis Fire Equipment
109 East Broadway / Alexis, IL 61412
 800-322-2284  sales@alexisfire.com
 AlexisFire.com

SERVICE CENTER:

The Alexis Priority-One service team is staffed with factory trained mechanics ready to meet your service requirements. Our staff is continually working on maintaining updated EVT and ASE certification.

The Alexis Service Team is available 24 hours a day, 7 days a week for your service emergencies. We use the latest paging system for fast, efficient and reliable service.

Our service facility covers an area of approximately 14,000 square feet.

The Alexis Service Team can assist you in fire apparatus service, ambulance service, aerial device maintenance, generator and rescue tool maintenance and service, and air pack inspections. Our staff can provide our customers with a complete apparatus training program, meeting the latest training requirements.

Alexis is a single source warranty center for the following manufacturers: Spartan Motors, Darley, Hale, and Waterous.

Our service team has over 50 years of cumulative experience in the fire service industry. In addition, they are backed by our fabrication, electrical, and paint and finish departments. This combination of training and hands-on experience offers true reliability and dependability.

Alexis keeps detailed documentation of all repair, maintenance, and inspection performed by our personnel. With time and manpower at such a premium among many fire departments, why not allow the Alexis Service Team to set up and maintain records for your fleet?

The Alexis Service Team is committed to providing prompt and courteous service, quality products and fair pricing.

Business: Alexis Fire Equipment Company
Contact Person: Barb Lafferty
Location: 109 East Broadway Alexis, IL 61412
Phone: 800-322-2284



 Alexis Fire Equipment
109 East Broadway / Alexis, IL 61412
 800-322-2284  sales@alexisfire.com
 AlexisFire.com

DELIVERY:

The finished apparatus shall be picked up by the dealer organization at the plant site of the Alexis Fire Equipment Company in Alexis, Illinois.

To insure proper break-in of all drive train components while under warranty, the finished apparatus shall be delivered to the purchaser under its own power.

The apparatus shall be covered by comprehensive and liability insurance during the delivery period. The purchaser shall assume the insurance obligation on acceptance, and at that time shall present to the manufacturer's agent a certificate of verification, showing liability, comprehensive and collision insurance coverage.



GENERAL INFORMATION:

LOCATION

The Alexis Fire Equipment facilities are located at 109 East Broadway, Alexis, Illinois 61412. We maintain a complete stock of parts and services available around-the-clock. We also propose to maintain parts and service for a minimum period of twenty (20) years on all apparatus which is manufactured.

NOTATION

To further assure the customer of our ability to manufacture quality fire apparatus, we are proud of the fact that Alexis Fire Equipment Company is family-owned and has been in the fire apparatus business since 1947. All apparatus manufactured by Alexis Fire Equipment are designed and built to meet the requirements of the latest edition of NFPA 1901.

PERSONNEL CAPACITIES

To meet the spirit of N.F.P.A. 1500 paragraph 6.3.1, this apparatus has been designed to transport not more than five (5) people.

6.3 Riding in Fire Apparatus

6.3.1 All persons riding in fire apparatus shall be seated and belted securely to the vehicle by seat belts in approved riding positions and at any time the vehicle is in motion. Standing or riding on tailsteps, sidesteps, running boards or in any other exposed position shall be specifically prohibited.

INFORMATION TO BE PROVIDED:

Alexis Fire Equipment Company shall supply, at the time of delivery, the following documents:

- A) The manufacturer's record of apparatus construction details, including the following information:
1. Owner's name and address
 2. Apparatus manufacturer, model, and serial number.
 3. Chassis make, model, and serial number.
 4. GAWR of front and rear axles.
 5. Front tire size and total rated capacity in pounds.

6. Rear tire size and total rated capacity in pounds.
 7. Chassis weight distribution in pounds with water and manufacturer mounted equipment.
 8. Engine make, model, serial number, number of cylinders, bore, stroke, displacement and compression ratio, rated horsepower and related speed, and no-load governed speed.
 9. Type of fuel and fuel tank capacity.
 10. Electrical system voltage and alternator output in amps.
 11. Battery make and model, capacity in CCA.
 12. Transmission make, model, and type.
 13. Pump to drive through the transmission (yes or no)
 14. Engine to pump gear ratio used
 15. Pump make, model, rated capacity in g.p.m., serial number, number of stages, and impeller diameter in inches.
 16. Pump transmission make, model, and serial number.
 17. Priming device type.
 18. Type of pump pressure control system.
 19. Auxiliary pump make, model, rated capacity in g.p.m., serial number, number of stages, and impeller diameter in inches.
 20. Water tank certified capacity in gallons.
 21. Aerial device type, rated vertical height in feet, rated horizontal reach in feet, and rated capacity in pounds.
 22. Paint numbers
 23. Company name and signature of responsible company executive.
- B) If the apparatus has a fire pump, the pump manufacturer's certification of suction capability.
- C) If the apparatus has a fire pump, a copy of the apparatus manufacturer's approval for stationary pumping applications.
- D) If the apparatus has a fire pump, the engine manufacturer's certified brake horsepower curve for the engine furnished, showing the maximum no-load governed speed.
- E) If the apparatus has a fire pump, the pump manufacturer's certification of hydrostatic test.
- F) If the apparatus has a fire pump, the certification of inspection and test for the fire pump.
- G) If the apparatus has an aerial device, the certification of inspection and test for the aerial device.
- H) If the apparatus has an aerial device, all the technical information required for inspections to comply with NFPA.
- I) Weight documents from a certified scale - showing actual loading on the front axle, rear axle(s), and overall vehicle (with the water tank full but without personnel, equipment, and hose) - shall be supplied with the completed vehicle.
- J) Written load analysis and results of the electrical system performance tests.
- K) If the apparatus is equipped with a water tank, the certification of water tank capacity.
- L) If the apparatus has a fire pump, two (2) copies of the pump operation and maintenance manual.
- M) Two (2) destination effective wiring diagrams.

- N) Copies of electrical and mechanical component manuals for equipment purchased on or with the apparatus.
- O) A sketch of the booster tank indicating all dimensions and baffle locations.
- P) If the apparatus has a pump, one (1) certification of third party test

WARRANTY:

Alexis Fire Equipment Co., Inc. warrants each new piece of Ashland Series fire and rescue apparatus to be free from defects in material and workmanship under normal use and service. Our obligation under this warranty is limited to repairing or replacing, as the company may elect, any part or parts thereof which shall be returned to us with transportation charges prepaid, and as to which examination shall disclose to the company's satisfaction to have been defective, provided that such part, or parts shall be returned to us not later than one year after delivery of such vehicle. Such defective part or parts will be repaired or replaced free of charge and without charge for installation to the original purchaser. All water tanks will be warranted as stated herein and may have extended warranty as explained elsewhere in the Alexis Fire Equipment Co. Proposal.

This warranty will not apply:

1. To normal maintenance service or adjustments.
2. To any vehicle which shall have been repaired or altered outside of our factory, in any way so as, in our judgement, to affect its stability, nor which has been subject to misuse, negligence, or accident, nor to any vehicle made by us which shall have been operated at a speed exceeding the factory rated speed, or loaded beyond the factory rated load capacity.
3. To the chassis and associated equipment furnished with chassis, signaling device, generators, batteries or other trade accessories. These are usually warranted separately by their respective manufacturers.
4. To work performed by an outside service without prior authorization obtained from Alexis Fire Equipment.
5. To costs incurred from an outside service for non-warranty related items.

This warranty is in lieu of all other warranties, expressed or implied, and all other representations to the original purchaser and all other obligations or liabilities, including liability for incidental or consequential damages on the part of the company. We neither assume or authorize any other person to give or assume any other warranty or liability on the company's behalf unless made or assumed in writing by the company.



LENGTH AND/OR HEIGHT LIMITATIONS:

OVERALL HEIGHT:

There shall be no overall height restrictions.

OVERALL LENGTH:

There shall be no overall length restrictions.

STATEMENT OF EXCEPTIONS – CHASSIS SYSTEMS:

The chassis to be utilized for this apparatus shall incorporate the OEM seat belt system and as such is not designed to comply with NFPA 1901-2016 Section 14.1.3 regarding seat belt design, seat belt web length, and the color requirements of the seat belts.

The chassis is supplied with an OEM installed seat belt indicator system; however, it will not specifically comply with requirements of NFPA 1901-2016 Section 14.1.3.9.

In addition, the chassis manufacturer will not allow an apparatus manufacturer to access any of the data from its electrical system to comply with NFPA 1901-2016 Sections 4.11 and 14.1.3.9; Vehicle Data Recorder and Seat Belt Indicator System.

Unauthorized access to the chassis electrical system voids all warranties and transfers all liability away from the chassis manufacturer. Due to this restriction, a Vehicle Data Recorder and a Seat Belt Indicator System will not be supplied or installed by Alexis Fire Equipment Company with this vehicle.

We hereby certify by the following signatures that we have read, understand and accept that upon delivery, the vehicle supplied by Alexis Fire Equipment Company will not specifically comply with NFPA Standard 1901-2009 Sections 4.11, 14.1.3, and 14.1.3.9.

ALEXIS FIRE EQUIPMENT COMPANY

FIRE DEPARTMENT

Signature

Signature



 Alexis Fire Equipment
109 East Broadway / Alexis, IL 61412
 800-322-2284  sales@alexisfire.com
 AlexisFire.com

Printed Name

Printed Name

Title

Title

Date

Date

BLACK PODIUM STEPS:

One (1) set of n-FAB Podium Textured Black stainless steel nerf bars, Model NFB-HPF1585CC-TX, shall be installed under the chassis cab doors.

The Podium Steps feature:

- Main tube fits high & tight to the vehicle body
- Stainless steel construction in textured black powder coat
- Fully welded 1-piece construction for strength, long lasting durability, & ease of installation
- Drop down step design and location is engineered to allow for ease of access on stock or lifted vehicles

WHEEL DRESS FULL WHEEL LINERS:

The front and rear wheels shall be dressed with polished, stainless steel wheel liners, hub covers and lug nut covers. Realwheels Model RW1600-2AK.

FUEL TANK:

The chassis shall incorporate a rear fuel tank installed by the chassis manufacturer. The fill and vent shall be installed behind the left rear wheel. The fill shall be labeled with the type of fuel intended.

DIESEL EXHAUST FLUID TANK:

The chassis shall incorporate a DEF Fluid tank installed by the chassis manufacturer. The DEF tank shall be relocated utilizing a Ford DEF tank relocation kit. The fill shall be installed in the right side pump panel. The fill shall be labeled with the type of fluid intended.

CHROME GRILLE GUARD:

One (1) Go Industries 33648B grill guard with black finish shall be installed on the front of the Ford Super Duty chassis. The grille guard includes the Go Industries 26648B Headlight extensions. One (1) Go Industries 33603 winch receiver plate is included.

12-volt electrical connections for a portable winch shall be provided.

HELMET STORAGE:

To meet the intent of NFPA 14.1.8.4.1, the helmet for each occupant shall be stored in an exterior compartment.

PUMP AND PIPING:

MIDSHIP PUMP:

MANUFACTURER: Hale Fire Pump Co.
MODEL: DSD150

CAPACITY: 1500 gpm. @ 150 psi.
SUCTION SIZE: 6" NST

PUMP ASSEMBLY

The pump shall be of a size and design to mount on the chassis rails of commercial and custom truck chassis, and have the capacity of 1500 gallons per minute (U.S. GPM), NFPA-1901 rated performance.

The entire pump shall be assembled and tested at the pump manufacturer's factory.

The pump shall be driven by a driveline from the truck transmission. The engine shall provide sufficient horsepower and RPM to enable pump to meet and exceed its rated performance.

The entire pump shall be hydrostatically tested to a pressure of 600 psi. The pump shall be fully tested at the pump manufacturer's factory to the performance spots as outlined by the latest NFPA Pamphlet No. 1901. Pump shall be free from objectionable pulsation and vibration.

The pump body and related parts shall be of fine grain alloy cast iron, with a minimum tensile strength of 30,000 psi. (2069 bar.) All metal moving parts in contact with water shall be of high quality bronze or stainless steel. Pump utilizing castings made of lower tensile strength cast iron not acceptable.

Pump body shall be vertically split, on a single plane for easy removal of entire impeller assembly including clearance rings

Pump shaft to be rigidly supported by two bearings for minimum deflection. The bearings shall be heavy-duty, deep groove ball bearings in the gearbox and they shall be splash lubricated.

Pump impeller shall be hard, fine grain bronze of the mixed flow design; accurately machined hand

ground and individually balanced. The vanes of the impeller intake eyes shall be hand ground and polished and be of sufficient size and design to provide ample reserve capacity utilizing minimum horsepower.

Impeller clearance rings shall be bronze, easily renewable without replacing impeller or pump volute body.

The pump shaft shall be heat-treated, electric furnace, corrosion resistant stainless steel. Pump shaft must be sealed with double-lip oil seal to keep road dirt and water out of gearbox.

GEARBOX

Pump gearbox shall be of sufficient size to withstand up to 16,000 lbs. ft. of torque of the engine. The drive unit shall be designed of ample capacity for lubrication reserve and to maintain the proper operating temperature.

The gearbox drive shafts shall be of heat-treated chrome nickel steel and at least 2 $\frac{3}{4}$ " in diameter, on both the input and output drive shafts. They shall withstand the full torque of the engine.

All gears, both drive and pump, shall be of highest quality electric furnace chrome nickel steel. Bores shall be ground to size and teeth integrated and hardened, to give an extremely accurate gear for long life, smooth, quiet running, and higher load carrying capability. An accurately cut spur design shall be provided to eliminate all possible end thrust. (No exceptions.)

The pump ratio shall be selected by the apparatus manufacturer to give maximum performance with the engine and transmission selected.

HALE ESP -12 PRIMING PUMP:

The priming pump shall be a positive displacement, oil-less rotary vane electric motor driven pump conforming to the requirements of NFPA 1901. The pump body shall be manufactured of heat-treated anodized aluminum for wear and corrosion resistance.

The pump shall be capable of producing a minimum 24 Hg vacuum at 2000 feet above sea level.

The electric motor shall be a 12 VDC totally enclosed unit.

The priming pump shall not require lubrication.

The priming pump shall be operated by a single push-pull control valve mounted on the pump operator

panel. The control valve shall be of all bronze construction.

DRIVELINES:

The chassis drivelines shall be modified to accept the pump drivelines. The pumping system drivelines shall be manufactured by the apparatus manufacturer. The drivelines shall be professionally balanced by the apparatus manufacturer to ensure complete system balance.

6" SUCTION:

One (1) 6" NST suction shall be located on the left side of the apparatus body. The suction shall be open and not gated. An inlet screen and a 6" handle cap shall be included.

PIPING:

The piping will be stainless steel material throughout the waterway system. The suction waterway shall be 6" 304 stainless steel material. The suction waterways shall be designed to flow a minimum of 17% in excess of the rated capacity from draft. The suction piping shall incorporate a 4" suction inlet to allow for full flow from the tank valve assembly. The suction piping shall be adapted from 6" TIPT to NST with a chrome adapter. The suction system shall be designed with 6" victaulic couplings to allow ease of access for maintenance or removal of the pumping system.

The discharge system shall incorporate a 4" stainless steel distribution system. The manifold shall be fed from the 4" piping system. The discharge system shall incorporate a 4" victaulic system to allow ease of access for maintenance or removal of the pumping system. Each discharge shall be fed from above the manifold system.

PUMP DRAINS:

The entire pump and its controls shall be drainable with a master drain piped to the lowest points of the pump and its control piping. The master drain shall be of a threaded design that will seal all drain points without allowing recycle.

HALE MECHANICAL SEAL:

The mechanical seal must be 2" in diameter and shall be spring loaded, maintenance free and self-adjusting. Mechanical seal construction shall be a carbon sealing ring, stainless steel coil spring, Viton rubber cup, and a tungsten carbide seat with Teflon backup seal.

AIR PUMP SHIFT:

The shifting mechanism shall be a heat-treated, hard anodized aluminum power cylinder, with stainless steel shaft. The assembly shall be plumbed utilizing a 3/8" air line for maximum performance. An in-cab control for rapid shift shall be provided that locks in road or pump.

For automatic transmissions, three green warning lights shall be provided to indicate to the operator(s) when the pump has completed the shift from Road to Pump position. Two green lights to be located in the truck driving compartment and one green light on pump operators panel adjacent to the throttle control. For manual transmissions, one green warning light will be provided for the driving compartment. All lights shall have appropriate identification/instruction plates.

AUXILIARY COOLING SYSTEM:

The apparatus shall feature an auxiliary cooling system. The system shall be comprised of two (2) Perma Cool Model 19122 12" pusher fans located in front of the radiator. The fans shall be activated with the pump interlock and will be operational whenever the apparatus is in pump gear.

INTAKE PRESSURE RELIEF VALVE

One (1) Task Force Tips model #A1860 pressure relief valve shall be provided. The valve shall have an easy to read adjustment range from 90 to 300 PSI with easy to read 90, 125, 150, 200, 250, 300 psi settings and an "OFF" position. Pressure adjustment can be made utilizing a 1/4" hex key, 9/16" socket or 14mm socket. For corrosion resistance the cast aluminum valve shall be hardcoat anodized with a powder coat interior and exterior finish. The valve shall be configured for either a Waterous or Hale pump, and have a 2-1/2" male NH threaded discharge outlet and a "DO NOT CAP" label near discharge outlet. The valve shall meet NFPA 1901 requirements for pump inlet relief valve. The unit shall be covered by a five-year warranty.

REQUIRED PUMP TESTING:

If the fire pump has a rated capacity of 750 gpm or greater capacity, the pump shall be tested after the pump and all its associated piping and equipment have been installed on the apparatus. The tests shall be conducted at the Alexis facility and certified by an EVT Certified pump operator. The certification shall include (at least) the following tests: the pumping test, the pumping engine overload test, the pressure control system test, the priming device tests, and the vacuum test. If the apparatus is equipped with a water tank, the water tank to pump flow test shall be included.

A test plate shall be provided at the pump operator's position that gives the following information: the rated discharges and pressures, the speed of the engine determined by the certification test for each unit, the position of the parallel/series pump as used, and the no-load governed speed of the engine stated by

the engine manufacturer on a certified brake horsepower curve. The plate shall be completely stamped with all information at the factory and attached to the vehicle prior to shipping.

PUMP CERTIFICATION:

Upon final apparatus delivery, the original copy of the certificate of inspection by an independent third party shall be furnished.

The pumping system shall be capable of delivering:

100 % of rated capacity at 150 psi. net pump pressure

70 % of rated capacity at 200 psi. net pump pressure

50 % of rated capacity at 250 psi. net pump pressure

PUMP MODULE - SIDE CONTROL:

A free standing pump module shall be located between the chassis cab and the body.

The pump module shall be a self-supported structure mounted to the frame separate from the cab and body. Pump module design beginning with a formed framework assemblies that are precision manufactured. This framework mounts to the truck frame through a mounting design complimented with four (4) VIBRA mount elastomer cushions. The result shall be a mounting system that allows for the twisting movement of the truck frame without undue stress loading of the pump module.

The pump operator's panel shall be located on the left side of the apparatus, and the suction/discharge panels shall be located on the left and right sides of the apparatus.

An automotive rubber seal shall be adhered to the pump panel to reduce vibration that may occur during pump operation or road application. The panel shall be attached to the framing with 3/16" pin, 1" knuckle, continuous stainless steel hinges. The hinges shall be attached with stainless steel fasteners.

Each panel shall be secured with latches at the top and bottom of the door opening.

The top left operator's panel shall be hinged for access to the individual gauges and the electrical components. No exceptions.

PUMP OPERATOR'S PANEL:

The pump operator's panel shall include the following:

PRESSURE GOVERNOR and MONITORING DISPLAY

One (1) Fire Research PumpBoss series PBA406-C00 pressure governor and monitoring display kit shall be installed. The kit shall include a control module, intake pressure sensor, discharge pressure sensor, and cables. The control module case shall be waterproof and have dimensions not to exceed 6 3/4" high by 4 5/8". The control knob shall be 2" in diameter with no mechanical stops, have a serrated grip, and a red idle push button in the center. It shall not extend more than 1 3/4" from the front of the control module. Inputs for monitored engine information shall be from an installed J1939 Translator Module. Outputs for engine control shall be on engine specific wiring. Inputs from the pump discharge and intake pressure sensors shall be electrical.

The following continuous displays shall be provided:

- Engine RPM; shown with four daylight bright LED digits more than 1/2" high
- Check engine and stop engine warning LEDs
- Engine oil pressure; shown on a dual color (green/red) LED bar graph display
- Engine coolant temperature; shown on a dual color (green/red) LED bar graph display
- Transmission Temperature: shown on a dual color (green/red) LED bar graph display
- Battery voltage; shown on a dual color (green/red) LED bar graph display
- Pressure and RPM operating mode LEDs
- Pressure / RPM setting; shown on a dot matrix message display
- Throttle ready LED.

The dot-matrix message display shall show diagnostic and warning messages as they occur. It shall show monitored apparatus information, stored data, and program options when selected by the operator. All LED intensity shall be automatically adjusted for day and night time operation.

The program shall store the accumulated operating hours for the pump and engine to be displayed with the push of a button. It shall monitor inputs and support audible and visual warning alarms for the following conditions:

- High Battery Voltage
- Low Battery Voltage (Engine Off)
- Low Battery Voltage (Engine Running)
- High Transmission Temperature
- Low Engine Oil Pressure
- High Engine Coolant Temperature
- Out of Water (visual alarm only)
- No Engine Response (visual alarm only).

The program features shall be accessed via push buttons located on the front of the control module. There shall be a USB port located at the rear of the control module to upload future firmware enhancements.

The governor shall operate in two control modes, pressure and RPM. No discharge pressure or engine RPM variation shall occur when switching between modes. A throttle ready LED shall light when the interlock signal is recognized. The governor shall start in pressure mode and set the engine RPM to idle. In pressure mode the governor shall automatically regulate the discharge pressure at the level set by the operator. In RPM mode the governor shall maintain the engine RPM at the level set by the operator except in the event of a discharge pressure increase. The governor shall limit a discharge pressure increase in RPM mode to a maximum of 30 psi. Other safety features shall include recognition of no water conditions with an automatic programmed response and a push button to return the engine to idle.

The pressure governor and display shall be programmed to interface with a Ford 6.7L diesel engine.

MASTER GAUGES:

One (1) 4½" compound gauge with a range of 30-0-400 PSI.

One (1) 4½" pressure gauge with a range of 0-400 PSI

WATER TANK INDICATOR

One (1) Fire Research TankVision Pro model WLA300-A00 tank indicator kit shall be installed. The kit shall include an electronic indicator module, a pressure sensor, and a 10' sensor cable. The indicator shall show the volume of water in the tank on nine (9) easy to see super bright RGB LEDs. A wide view lens over the LEDs shall provide for a viewing angle of 180 degrees. The indicator case shall be waterproof, manufactured of Polycarbonate/Nylon material, and have a distinctive blue label.

The program features shall be accessed from the front of the indicator module. The program shall support self-diagnostics capabilities, self-calibration, six (6) programmable colored light patterns to display tank volume, adjustable brightness control levels and a datalink to connect remote indicators. Low water warnings shall include flashing LEDs at 1/4 tank, down chasing LEDs when the tank is almost empty, and an output for an audio alarm.

The indicator shall receive an input signal from an electronic pressure sensor. The sensor shall be mounted from the outside of the water tank near the bottom. No probe shall be placed on the interior of the tank. Wiring shall be weather resistant and have automotive type plug-in connectors.

The gauge shall be located at the pump operator's panel.

LINE READING GAUGES:

One (1) line reading gauge supplied for each discharge. The gauge shall have a 2½ diameter face with a graduated output scale of 0-400 PSI with black print on a bright white background. The gauge shall be constructed with a Zytel housing, acrylic lens and polished stainless steel bezel. The Zytel nylon case shall be temperature compensated with an internal breathing diaphragm to permit a fully filled case and to allow for a rigid lens with a distortion free viewing area.

A 1/4" brass male NPT fitting shall be centrally located on the rear of the housing and feature the Kem-X socket and freeze protection system that isolates the gauge from contaminants. The gauge utilizes a phosphor bronze Bourdon tube filled with a freeze proof liquid isolated by a diaphragm. The gauge shall be filled with low temperature glycerin for an operating range of -40 to +150 degrees Fahrenheit, which prevents bouncing of the readout needle and provides for an accuracy rating of plus or minus 1% across the entire scale of the gauge.

COLOR CODED TAGS:

Color coded tags with chrome plated bezels shall be provided. Unless otherwise specified all tags shall be color coded to NFPA recommendations and shall be located at the control location, intake/discharge location, and at the drain port location.

Alexis Standard Tags:

Front Bumper Jump Line	Orange
Preconnect #1	Red
Preconnect #2	Yellow
Preconnect #3	Seafoam
Discharge #1	White
Discharge #2	Blue
Discharge #3	Black
Discharge #4	Green
Discharge #5/Water tower	Purple
Deluge/deck gun	Silver
Large-diameter hose	Yellow with white border
Foam line(s)	Red with white border
Booster reel(s)	Gray
Inlets	Burgundy

TEST PORTS:

Vacuum and pressure test ports shall be provided on the pump operator's panel for connection of the pump test gauges.

RUNNING BOARDS

The running boards shall be constructed of 3/16" thick 3003-H14 aluminum treadplate and shall be attached to the outriggers on the pump module. The aluminum treadplate meets NFPA standard 13-7.3: all exterior surfaces have a minimum slip resistance of .68.

RUB RAILS - RUNNING BOARDS:

Bolt on aluminum rub rails shall be installed one (1) each side on the running boards. Said rub rails will be fabricated of a polished "C" channel aluminum, mounted to the running board utilizing 1/4" plastic spacers.

The rub rails shall incorporate the LED ground lights. Each light strip shall run the full length of each rub rail.

The channel designed rub rail shall incorporate a highly reflective red and fluorescent yellow green reflective stripe to aid in apparatus protection.

STAINLESS STEEL PUMP MODULE:

The area above the side discharge panels on each side shall be manufactured of 14 gauge brushed stainless steel material.

STAINLESS STEEL PUMP PANELS:

The pump operator's panel and discharge panels shall be manufactured of 12-gauge stainless steel and shall include a full width light hood.

The lights shall be activated by a switch located on the pump operator's panel.

PUMP MODULE TOP:

TWO (2) 1½" MATTYDALE PRECONNECTS:

Two (2) Mattydale 1½" preconnects shall be located across the top of the apparatus body. The preconnects shall incorporate a 1½", 180° swivel adapted to 1½" fire hose thread. The waterways shall be 2" i.d. and include a 2" full flow quarter turn ball valve that is remote controlled from the operator's panel (NFPA 4-7.2).

Each preconnect shall have the capacity to contain a minimum of 200 ft. of 1¾" hose. The mattydale preconnects shall be designed as to allow the extension of hose to the left or right side of the apparatus body. The preconnect openings shall incorporate aluminum abrasion plates to protect the body finish from the hose and its couplings when the hose is being extended or relayed.

Each above valve shall be manually controlled.

MATTYDALE PRECONNECT COVER - HYPALON:

The Mattydale preconnect area shall be covered with a fire and chemical resistant material. It is to be retained to the apparatus with a shock cord and nylon clip system.

The hypalon cover shall be black in color.

2 ½" DISCHARGE PIPING:

Two (2) 2 ½" discharge(s) shall be located on the left side of the apparatus. Each discharge valve shall be located behind the body panel and controlled from the side control pump operator's panel. Each discharge shall include a self-locking 2½" quarter-turn ball valve, a 2½" chrome cap with chain, and a sweep elbow of at least 30 degrees downward.

Each above valve shall be manually controlled.

2 ½" DISCHARGE PIPING:

One (1) 2 ½" discharge(s) shall be located on the right side of the apparatus. Each discharge valve shall be located behind the body panel and shall be controlled from the side control pump operator's panel. Each shall include a self-locking 2½" quarter-turn ball valve, a 2½" chrome cap with chain, and a sweep elbow of at least 30 degrees downward.

Each above valve shall be manually controlled.

PRECONNECT(S), 2 ½" FRONT OF HOSE BED:

One (1) 2½" preconnect(s) shall be located at the front of the apparatus hose bed on the right side. Each preconnect shall include 2½" full flow waterways and a 2½" full flow quarter turn ball valve that is remote controlled with a push/pull control from the pump panel.

3" DISCHARGE(S), APPARATUS RIGHT SIDE:

One (1) 3" discharge(s) shall be located on the right side of the apparatus with each valve behind the body panel. Each discharge shall be controlled from the side control pump operator's panel. A 2½" gauge shall be adjacent to each control. Each valve shall measure 3" and include an Akron Slo-Cloz adapter.

DISCHARGE ADAPTER:

The 3" discharge shall incorporate one (1) 3" NST LHF x 5" Storz 30 degree elbow with blind cap.

Each above valve shall be manually controlled.

TANK TO PUMP LINE:

One (1) 3" tank to pump line shall be installed into the tank to the suction side of the pump. It shall have 4" piping and valved with a 3" full flow valve. The valve shall be controlled from the pump operator's panel. The tank line shall incorporate a check valve in the line to meet NFPA 1901.

LINE DRAINS FOR DISCHARGES:

The drain valves shall be Innovative Controls ¾" ball brass drain valves with chrome-plated lift lever handles and ergonomic grips. Each lift handle grip shall feature built-in color-coding labels and a verbiage tag identifying each valve, also supplied by Innovative Controls. The color labels shall also include valve open and close verbiage.

VENTED DISCHARGE CAPS:

Each discharge shall incorporate a vented cap designed to relieve stored pressure in the line when disconnected.

GATED SUCTION, LEFT SIDE:

One (1) 2½" gated suction shall be located on the left side of the apparatus. It shall be piped 2½" i.d. including a 2½" Akron full flow quarter turn valve and a 2½" NST female swivel with plug and chain. It shall be remote controlled from the suction location.

Each above valve shall be manually controlled.

REAR SUCTION:

One (1) 5" suction shall be located at the apparatus rear. It shall be piped with 5" butterfly valve, adapted as described below. An inlet screen and a long handle cap shall be included. The operator has an "Open/Closed" indicator device showing the valve position at all times. The butterfly valve shall be made of lightweight aluminum alloy with a bronze valve disc and one (1) piece rubber seat. It shall be rated at 250 psi. working pressure. The electric actuator shall have a worm gear drive system with emergency manual override. All of the controls shall be within a single panel mountable package, which utilizes current limiting for fully open and closed stopping. There shall be no switches in the gear actuator housing.

INTAKE RELIEF VALVE:

One (1) TFT A1860 intake relief valve shall be installed on the auxiliary intake of the pump. The minimum range shall permit control from 75 to 250 psi. (per NFPA 4-5.1).

One (1) 5" NPTF x 6" NSTM with screen, chrome plated.

SUCTION LINE DRAINS:

Each 2½" gated suction and those of larger sizes shall incorporate a ¾" quarter turn drain hoses to ground. The drain shall be located behind the body panel, remote controlled from the suction location.

TANK FILL RECYCLE:

One (1) 2" waterway shall be incorporated from the pressure side of the pump to the tank. The line shall be controlled from the pump panel and valved with a 2" ball valve to allow a pump cooling recycle or tank fill when pumping from draft. When fully opened, it shall have the capacity to refill the tank at 750 gpm when pumping at 100 psi.

VALVING:

Each and every apparatus valve must be an Akron Stainless Steel Ball Valve, per the following specifications.

An Akron Brass Generation II Swing-Out™ Valve, shall be provided. The valve shall have an all brass body with flow optimizing stainless steel ball and dual polymer seats. The valve body shall be of universal design and accept multiple actuators. The valve shall be capable of dual directional flow while incorporating a self-locking ball feature using an automatic friction lock design and specially designed flow optimizing stainless steel ball. The stainless steel ball shall have HydroMax™ technology. All stainless steel parts must be 316 grade for increased resistance to corrosion. The valve shall not require lubrication of seats or any other internal waterway parts, and must be capable of

swinging out of the waterway for maintenance by the removal of six bolts. The valve shall be compatible with a slow closing device. This valve shall be actuated using a manual handle. The handle shall be quickly adjustable to one of eight handle positions and require only 90° travel. The valve shall be manufactured and assembled in the United States. Product must carry a 10 year manufacturer's warranty.

WARRANTY, AKRON BRASS BALL VALVE:

We warrant Akron Brass Swing-Out Valves for a period of ten (10) years after purchase against defects in material or workmanship. Akron Brass will repair or replace any Swing-Out Valve which fails to satisfy this warranty. Repair or replacement shall be at the discretion of Akron Brass. Electrical Components shall carry our standard five (5) year warranty. We will not be responsible for: Wear and tear; and by improper installation use, maintenance; negligence of the owner or user; repair or modification after delivery; failure to follow our instructions or recommendations; or anything else beyond our control. WE MAKE NO WARRANTIES EXPRESS OR IMPLIED, OTHER THAN THOSE INCLUDED IN THIS WARRANTY STATEMENT, AND WE DISCLAIM ANY IMPLIED WARRANTY OF MERCHANTABILITY OR FITNESS FOR ANY PARTICULAR PURPOSE. Further we will not be responsible for any consequential, incidental, or indirect damages (including, but not limited to, any loss of profits) from any cause whatsoever. No person has authority to change this warranty.

PIPING:

All waterways described herein shall be of schedule 40 threaded stainless steel pipe, schedule 10 welded stainless steel, or "aeroquip" hose. Each shall be installed with the proper couplings to allow apparatus twisting, flexing, and complete removal for service or replacement.

PLUMBING WARRANTY:

The stainless steel plumbing components and ancillary brass fittings used in the construction of the water/foam plumbing system shall be warranted for a period of ten (10) years or 100,000 miles. This covers structural failures caused by defective design or workmanship, or perforation caused by corrosion, provided the apparatus is used in a normal and reasonable manner. This warranty is extended only to the original purchaser for a period of ten (10) years or 100,000 miles from the date of delivery.

PIPING CERTIFICATION:

Upon final apparatus delivery, a certification sheet shall accompany the unit stating that all piping and the pump have been hydrostatically tested to 250 psi.



BODY:

BODY WARRANTY:

Alexis Fire Equipment Company hereby extends its standard one-year fire and rescue apparatus warranty to include defects in materials and workmanship of the body as well as structural defects which, in the sole opinion of the company, substantially affect the total integrity of the body. This warranty is extended only to the original user-purchaser.

Alexis Fire Equipment warrants the 3/16" aluminum bodies, under normal use and with reasonable maintenance, shall remain structurally sound for a period of 10 years or 100, 000 miles as long as the design of the apparatus complies with Alexis engineering practices.

The Company reserves the right to require any such repairs to be made either at Alexis Fire Equipment Company, Inc. or another approved service facility, at the option of Alexis Fire Equipment. Transportation cost to and from the servicing location is the responsibility of the user-purchaser.

The warranty shall be null and void if, upon inspection by the Company, the alleged defect is determined to have been caused by abuse, modification, accident, neglect, or lack of proper maintenance.

This warranty does not apply to the following items that are covered by a separate warranty: paint finish, hardware, door assemblies, moldings, and other accessories attached to the body. In addition, this warranty does not apply to any part or accessory manufactured by others and attached to the body.

Alexis Fire Equipment will be given a reasonable opportunity to investigate all claims. The purchaser must commence any action arising out of, based upon or relating to agreement or the breach hereof, within twelve (12) months from the date the cause of the action occurred.

Alexis Fire Equipment makes no other warranty, expressed or implied, with respect to the apparatus body and all implied warranties of merchantability and fitness for a particular purpose are hereby disclaimed.

BODY:

BODY SUB FRAME:

The body subframe system shall be independent of the chassis frame and is to be constructed of aluminum structural material. The subframe shall be mounted in a manner that allows the body to float independent of the chassis frame. However, the unit will be secured in compliance with all chassis



manufacturers' frame requirements, as well as with all SAE FMVSS standard requirements. The chassis frame shall be completely cushioned from the subframe system with closed cell rubber.

FRONT BODY PANELS:

The front of the mini pumper body is manufactured of aluminum treadplate

ALUMINUM BODY PANELS:

The apparatus body panels shall be full height and independent of the tank's sides. The body panels shall be constructed of .190 thick 5052 aluminum material.

REAR BODY PANELS:

The rear of the mini pumper body is manufactured .190" smooth aluminum

ROOF OF THE APPARATUS:

The roof area of the apparatus body shall be manufactured of aluminum treadplate material. The material shall break over the sides 2".

WHEEL HOUSING, ALUMINUM TREADPLATE:

The rear wheel housing shall be constructed of aluminum treadplate and shall incorporate a black rubber fenderette. The circular interliner shall be manufactured of 1/8" smooth aluminum

COMPARTMENT DESIGN:

The compartmentation shall be fabricated of 3/16" (.1875") thick 5052 H32 aluminum. The compartmentation is designed to be an intricate part of the body and subframe for maximum compartment support. The compartment tops shall be fabricated of aluminum treadplate material. The material shall be formed over each compartment top to act as drip protection over each compartment opening. The compartment flooring will be sweep out design. The front face of the compartments shall be aluminum treadplate and the rear face the compartments shall be smooth aluminum in preparation for Chevron striping.

The specified lighting in each compartment shall be switched automatically with the doors. The lighting shall meet the requirements of NFPA 13.10.5

TAILSTEP:

The tailstep shall be constructed of .190 thick 3003-h14 aluminum treadplate. The tailstep shall be a bolt-on tailstep for ease of removal and repair. The aluminum treadplate meets NFPA standard 13-7.3: all exterior surfaces have a minimum slip resistance of .68.

REAR TOW EYES:

Two (2) ¾" thick steel tow eyes shall be securely fastened to the rear frame rails, one (1) each side. Each tow eye shall extend through the rear body panel

AIR BOTTLE COMPARTMENT:

Three (3) Model 101252-1X air bottle storage compartment(s) shall be located in the apparatus wheel well assemblies. For ease of access, each bottle shall be stored within an individual storage tube manufactured of poly material. The compartment shall incorporate a vertically hinged stainless steel door with a black push button latch. Each compartment shall have the capacity to carry one (1) air bottle.

LOCATION: One (1) Left and Two (2) Right

HOSE BED:

The hose bed shall be located over the booster tank, and must be accessible from the tail step and from its open top. The hose bed compartment shall have a minimum capacity of 22 cu. ft. and a minimum width of 48".

HOSE BED CAPACITY:

The hose bed shall have the capacity to carry the following hose from left to right:

HOSE BED DIVIDER:

One (1) divider shall be located in the hose bed. It shall be constructed of 3/16" aluminum plate. The divider shall be designed for future adjustability with locking blocks in aluminum channels at the front and the rear of the hose bed.

Each hose bed divider shall incorporate hand hold cutouts to assist in accessing the hose bed.

HOSE BED COVER:

One (1) custom tailored hypalon hose bed cover shall be included with the apparatus body. It shall be manufactured of a flame retardant material with a grab tensile of 480 x 500 lbs. and a tongue tear of 160 x 150 lbs. It shall be crack resistant to -40° Fahrenheit and have an adhesion lbs./in of 10.0 lbs. The hose bed cover shall be fitted to the hose bed and retained with a double woven shock cord on the front and both sides. The shock cord shall system shall utilize nylon hooks spaced every 10"-12". The cover shall be sand weighted across the rear flap and shall also include two (2) 2" wide nylon straps with teflon buckle to meet NFPA requirements.

The hose bed cover shall include a 3 year warranty.

The hypalon cover shall be black in color.

PAINTED ROLL-UP DOORS:

The side compartments shall have ROM Series IV Roll-up Shutter Doors with a **paint**ed finish. The doors shall be made of an anodized aluminum slat incorporating an exclusive seal that prohibits water intrusion, absorbs shock, eliminates clatter, and provides quiet, vibration-free performance. The lift bar shall be a D-shaped bar for strength and ease of use.

The rear compartment (if applicable) shall have ROM Series IV Roll-up Shutter Door with a **sat**in finish. The door shall be made of an anodized aluminum slat incorporating an exclusive seal that prohibits water intrusion, absorbs shock, eliminates clatter, and provides quiet, vibration-free performance. The lift bar shall be a D-shaped bar for strength and ease of use.

ROLL UP DOOR GUARD:

Each roll-up door shall incorporate a stainless steel guard. The guard shall be located at the top of the compartment around the roll-up door header to protect the finish of the roll-up door when the door is in the up position. The door opening height as stated will be reduced by approximately 2" to accommodate the door guard.

TALL BOTTOM RAIL:

Each ROM door shall incorporate a tall bottom rail for improved accessibility.

The roll-up door side tracks and top drip rail shall remain **sat**in finish.

LEFT SIDE:

L1

A roll-up door compartment assembly with a door opening of 19" wide x 48" high x 21" deep shall be provided ahead of the rear wheels on the left side.

The compartment shall include the following:

Unistrut Tracking

E45 Series LED strip lights to illuminate the entire area. The lights shall run the entire height of the compartment on each side of the door opening.

L2

A roll-up door compartment assembly with a door opening of 43" wide x 27" high x 21" deep shall be provided over the rear wheels on the left side.

The compartment shall include the following:

Unistrut Tracking

E45 Series LED strip lights to illuminate the entire area. The lights shall run the entire height of the compartment on each side of the door opening.

L3

A roll-up door compartment assembly with a door opening of 36" wide x 48" high x 21" deep shall be provided behind the rear wheels on the left side.

The compartment shall include the following:

Unistrut Tracking

E45 Series LED strip lights to illuminate the entire area. The lights shall run the entire height of the compartment on each side of the door opening.

RIGHT SIDE:

R1

A roll-up door compartment assembly with a door opening of 19" wide x 48" high x 21" deep shall be

provided ahead of the rear wheels on the right side.

The compartment shall include the following:

Unistrut Tracking

E45 Series LED strip lights to illuminate the entire area. The lights shall run the entire height of the compartment on each side of the door opening.

R2

A roll-up door compartment assembly with a door opening of 43" wide x 27" high x 21" deep shall be provided over the rear wheels on the right side.

The compartment shall include the following:

Unistrut Tracking

E45 Series LED strip lights to illuminate the entire area. The lights shall run the entire height of the compartment on each side of the door opening.

R3

A roll-up door compartment assembly with a door opening of 36" wide x 48" high x 21" deep shall be provided behind the rear wheels on the right side.

The compartment shall include the following:

Unistrut Tracking

E45 Series LED strip lights to illuminate the entire area. The lights shall run the entire height of the compartment on each side of the door opening.

REAR COMPARTMENT SHALL BE AS FOLLOWS:

A roll-up door compartment assembly with a door opening of 34" wide x 25" high x 41" deep shall be located at the rear of the apparatus.

E45 Series LED strip lights to illuminate the entire area. The lights shall run the entire height of the compartment on each side of the door opening.



RUB RAILS:

Bolt on aluminum rub rails shall be installed, below the compartment doors. Said rub rails will be fabricated of a polished "C" channel aluminum, mounted to the body surface utilizing ¼" plastic spacers. The channel designed rub rail shall incorporate a highly reflective red and fluorescent yellow green reflective stripe to aid in apparatus protection.

The rub rails shall incorporate the LED ground lights and LED lower warning lights. Each light strip shall run the full length of each rub rail.

DURATILE TILE ON FLOOR:

The floor of each main body compartment shall be covered with black Duratile Tile.

TANK:

BOOSTER TANK:

The tank shall have a capacity of 300 US gallons complete with a lifetime warranty. The tank manufacturer shall mark the tank and furnish notice that indicates proof of warranty. The purpose of the markings and notice is to inform department personnel who store, stock, or use the tank that the unit is under warranty. Markings may be brief but should include a short statement that a warranty exists, the substance of the warranty, its duration, and who to notify if the tank is found to be defective.

The tank shall be constructed of ½" thick PT2E polypropylene sheet stock. This material shall be non-corrosive stress relieved thermo-plastic and U.V. stabilized for maximum protection.

The booster tank shall be of a specific configuration and so designed to be completely independent of the body and compartments. All joints and seams shall be nitrogen welded and tested for maximum strength and integrity. The top of the booster tank is removable. The transverse swash partitions shall be manufactured of 3/8" PT2E polypropylene (natural in color) and extend from approximately 4" off the floor to just under the cover. The longitudinal swash partitions shall be constructed of 3/8" PT2E polypropylene (natural in color) and extend from the floor of the tank through the cover to allow for positive welding and maximum integrity. All partitions shall be equipped with vent and air holes to permit movement of air and water between compartments. The partitions shall be designed to provide maximum water flow. All swash partitions interlock with one another and are welded to each other as well as to the walls of the tank.

FILL TOWER AND COVER

The tank will have a combination vent and manual fill tower. The fill tower will be constructed of ½" PT2E polypropylene and shall be a minimum dimension of 8" x 8" outer perimeter. The tower will be located in the left front corner of the tank. The tower will have a ¼" thick removable polypropylene screen and a PT2E polypropylene hinged type cover. Inside the fill tower, approximately 4" down from the top, shall be fastened a combination vent overflow pipe. The vent overflow shall be a minimum of schedule 40 polypropylene pipe with a minimum I.D. of 4" that is designed to run through the tank and shall be piped behind the rear wheels.

The tank cover is constructed of ½" thick PT2E polypropylene and UV stabilized, to incorporate a multi three-piece design which allows for individual removal and inspection if necessary. The tank cover will be recessed 3/8" from the top of the tank and shall be welded to both sides and longitudinal partitions for maximum integrity. Each one of the three covers will have hold-downs consisting of 2" polypropylene dowels spaced a maximum of 30" apart. These dowels will extend through the covers and be welded to the transverse partitions. This will assist in keeping the cover rigid under fast filling conditions. A minimum of two (2) lifting dowels shall be drilled and tapped ½" x 13" to accommodate the lifting eyes.

SUMP

There will be one (1) sump standard per tank. The sump shall be constructed of ½" PT2E polypropylene and be located in the left front quarter of the tank. The sump will have a minimum 3" NPT threaded outlet on the bottom for a drain plug. This shall be used as a combination cleanout and drain. All tanks shall have an anti-swirl plate located approximately 2" above the sump.

OUTLETS

There will be two (2) standard tank outlets: one for the tank to pump suction line which will be a minimum of a 3" NPT coupling and one for a tank fill line which will be a minimum of a 2" NPT coupling. All tank fill couplings will be backed with flow deflectors to break up the stream of water entering the tank, and be capable of withstanding sustained fill rates of up to 1000 GPM. All auxiliary outlets and inlets must meet all NFPA guidelines in effect at the time of manufacture.

MOUNTING

The poly tank shall rest on the body cross members with an unsupported area not to exceed 530 sq. inches on tanks up to 40" in height. On tanks over 40" in height, an unsupported area of not more than 400 sq. inches must be maintained. All tanks shall be isolated from the cross members through the use of hard rubber strips with, a minimum thickness and width dimension of .250 x 2" and a minimum Rockwell hardness of 60 durometer. Additionally, the tank must be supported around the entire bottom

outside perimeter and captured both front and rear as well as side to side to prevent the tank from shifting during vehicle operation. A picture frame type cradle mount shall be utilized with a minimum of 2" x 2" x .250 structural material.

Although the tank is designed on the free-floating suspension principle, it shall be required that the tank have hold down restraints half way between the front and the rear of the tank. These restraints shall be made of 3" x 3" x ¼" angle approximately 6" long. The restraints shall be mounted to the side walls of the hose bed and extend down so that they rest approximately ½" above the top of the tank. The tank shall be completely removable without disturbing or dismantling the apparatus structure.

Upon final apparatus delivery, proper evidence and certifications shall be presented indicating the tank has the capacity of flow to the pump 80% of its rated capacity at a flow rate of 300 GPM.

12 VOLT ELECTRICAL:

ELECTRICAL WARRANTY:

Alexis Fire Equipment Co., Inc. warrants each new piece of Ashland Series fire and rescue apparatus to be free from defects in material and workmanship under normal use and service. Our obligation under this warranty is limited to repairing or replacing, as the company may elect, any part or parts thereof which shall be returned to us with transportation charges prepaid, and as to which examination shall disclose to the company's satisfaction to have been defective, provided that such part, or parts shall be returned to us within three (3) years or 30,000 miles after delivery of such vehicle. Such defective part or parts will be repaired or replaced free of charge and without charge for installation to the original purchaser.

Items specifically covered are:

- Electrical harnesses and harness installation
- Printed circuit board
- Switches, circuit breakers and relays

Items excluded are:

- Chassis electrical systems and components installed by chassis manufacturer
- Separately manufactured items installed by Alexis Fire Equipment including, but not limited to; batteries, sirens, battery chargers, inverters, lightbars and similar equipment. (These are covered by warranties supplied by the manufacturer of the components).
- Periodic tightening and cleaning of connection terminals as this is considered routine maintenance
- Normal wear, abuse, accident, negligence or un-approved alteration of original parts.



Should repairs become necessary under the terms of this warranty, the extent of that repair shall be determined solely by Alexis Fire Equipment and shall be performed solely by Alexis Fire Equipment or a repair facility designated by Alexis. The expense of any transportation to or from such repair facility shall be that of the purchaser and is not an item covered by this warranty.

Alexis Fire Equipment reserves the un-restricted right at any time to make changes in design of and/or improvements on its products without thereby imposing any obligation on itself to make corresponding changes or improvements in or on its products theretofore manufactured.

12 VOLT ELECTRICAL SYSTEM:

Our electrical system is engineered to provide many years of dependable, trouble free service.

The 12 volt apparatus wiring shall be completely independent of the chassis electrical system. The system shall incorporate a state-of-the-art electrical distribution center. The center shall include a microprocessor, automatic reset circuit breakers, and switching relays.

12 VOLT DISTRIBUTION CENTER:

The 12 Volt distribution center shall be located in a poly box beneath the rear seats. The access panel shall incorporate a laminated wiring diagram for ease of maintenance of the electrical system.

A 12 volt fan shall be provided in the distribution center to enhance the air flow around the electrical equipment. The fan shall be switched with the master switch.

BATTERY CHARGER/AIR COMPRESSOR:

One (1) Progressive Dynamics PD2140 battery charger shall be installed on the vehicle. The unit shall be located in the L1 compartment.

The PD2140 is a 40-amp Electronic Marine Converter/Charger capable of charging up to three separate banks of batteries at the same time. It incorporates a microprocessor that constantly monitors battery voltage, then automatically selects one of four operating modes to ensure safe, rapid recharging cycles. The Storage Mode and the Equalize Mode of operation ensures minimum battery gassing and water loss while preventing battery stratification and sulfation. All Inteli-Power chargers are designed to meet the stringent requirements of the Marine environment and are UL listed for safety. A digital meter displays current, voltage, operation mode, blown fuse indication, and battery type.

One (1) Viair Model 460C air compressor shall be installed on the vehicle. The air compressor is a fully automatic system which is powered from the chassis battery bank through the PD2140 charger system.

The Viair compressor shall supply air to facilitate the air pump shift. The compressor shall be plumbed to one (1) manufacturer supplied auxiliary air tank.

KUSSMAUL SUPER AUTO EJECT SHORELINE CONNECTION - 120V:

One (1) Kussmaul super auto eject Model 091-55-20-120 with a standard yellow weather cover shall be installed on the apparatus. The super auto eject is a completely sealed automatic power line disconnect. One (1) 120-Volt shoreline shall be supplied between the fire station power and the apparatus.

The shoreline connection shall be located in the left rear wheel well area, ahead of the wheels.

MASTER SWITCH:

A 12 Volt Cole-Hersee Rotary switch shall be installed. When in the OFF position, the master switch system shall isolate all electrical power from the apparatus. It shall not interrupt any primary battery/starter wiring originally furnished by the chassis manufacturer.

FLOOR MOUNTED CONSOLE FOR EMERGENCY SWITCHES:

One (1) 12 volt floor mounted console shall be installed in the apparatus. The console shall be manufactured of black textured composite material. The console shall incorporate the switch row and two (2) slots, one (1) for the electronic siren and one (1) slot for the radio.

RADIO PROVISIONS:

One (1) customer supplied single head radio provision shall be provided in the chassis cab. The cutout shall accommodate the radio make and model specified and shall include a bezel specific to the radio specified.

RADIO WIRING:

Radio wiring shall be provided for the customer supplied and installed radio. The wiring shall include power and ground leads, battery direct and master switched.

ANTENNA:

One (1) Alexis Fire Equipment supplied antenna base, for use with an NMO type antenna, shall be mounted on the cab roof. The antenna base shall be a Motorola base designed for either thick or thin

roof material as appropriate for the application and shall include a custom length of RG58 A/U cable with no connector at the radio end of the cable. The cable shall terminate at the center console area.

The radio make and model shall be:_____

TIRE PRESSURE MONITORING DEVICE:

One (1) set of Real Wheels LED Air Guard tire pressure indicators shall be shipped loose with the completed apparatus. Features and benefits of the LED Air Guards include

- Safety – Improper tire pressure has a detrimental effect on handling, braking and control.
- Longer Tire Life – According to the D.O.T., 95% of all premature tire wear is caused by underinflation.
- Self-calibrating – LED AirGuard Set & Go memorizes pressure when initially installed and can be easily recalibrated by simply removing and reinstalling.
- Improved Fuel Economy – Proper tire inflation can save an estimated 3% to 5% in fuel costs.

CHASSIS HIGH IDLE:

The Ford chassis shall incorporate a high idle system installed by Alexis Fire Equipment Company. The high idle system shall utilize the chassis PCM to increase the engine RPM and shall be controlled by a single switch in the chassis cab. The high idle system shall be interlocked to the park brake, service brake, park (automatic transmissions) or the clutch (manual transmissions).

OPTICAL WARNING SYSTEM:

The optical warning system on the fire apparatus shall be capable of two separate signaling modes during emergency operations. One mode shall signal to drivers and pedestrians that the apparatus is responding to an emergency and is calling for the right-of-way. The other mode shall signal that the apparatus is stopped and is blocking the right-of-way.

EMERGENCY WARNING LIGHTS:

For the purpose of defining and measuring the required optical performance, the apparatus shall be divided into four warning zones. The four zones shall be determined by drawing lines through the geometric center of the apparatus at 45° to a line lengthwise of the apparatus through the geometric center. The four zones shall be designated A, B, C, and D in a clockwise direction with zone A to the front of the apparatus. Each zone shall have an upper and lower warning level.

Effective coverage of all four zones, both upper and lower, as required by the latest NFPA Edition shall

be provided.

LED LIGHTBAR:

One (1) Whelen Model F4N2VLED 55" LED lightbar shall be mounted at the front of the body. The lightbar shall be switched from the in cab switch panel. This lightbar fills the requirements of Zone A Upper, Zone B Upper, and Zone D Upper.

The light bar shall feature four (4) corner red LED modules, two (2) forward facing red LED modules, and two (2) forward facing clear LED Modules.

The clear modules shall extinguish when blocking the right of way per NFPA. A stinger switch shall also be provided for control of the white lights in inclement weather.

WARNING LIGHTS (FRONT):

Two (2) Tecniq Model K60-R*00-1 Red LED warning lights shall be mounted on the front brush guard, one (1) on each side. These lights shall be switched from the in cab switch panel. These lights fill the requirements of Zone A Lower.

Each light shall be mounted utilizing a chrome plated flange.

Each light shall incorporate a colored lens.

WARNING LIGHTS (SIDE):

One (1) Tecniq Model K50-R*00-1 Red LED warning light shall be mounted on the right (officer's) side of the front brush guard. The light shall be switched from the in cab switch panel. The light fills the requirements of Zone B Lower.

One (1) Tecniq Model K50-R*00-1 Red LED warning light shall be mounted on the left (driver's) side of the front brush guard. The light shall be switched from the in cab switch panel. The light fills the requirements of Zone D Lower.

The rub rails on each side of the body shall incorporate integral outward facing Red LED strip lights. In addition to the Red LED strip light, the rub rail on each side ahead of the rear wheels shall incorporate one (1) TecNiq E03-D001-1 LED light. These lights shall be switched from the in cab switch panel.

Each cab side light shall be mounted utilizing a chrome plated flange.



Each light shall incorporate a colored lens.

WARNING LIGHTS (SIDE):

One (1) Tecniq Model K60-R*00-1 Red LED warning light shall be mounted on the right (officer's) side of the vehicle in the upper area. The light shall be switched from the in cab switch panel.

One (1) Tecniq Model K60-R*00-1 Red LED warning light shall be mounted on the left (driver's) side of the vehicle in the upper area. The light shall be switched from the in cab switch panel.

These lights fill the requirements of Zones B & D Upper.

Each light shall be mounted utilizing a chrome plated flange.

Each light shall incorporate a colored lens.

WARNING LIGHTS (REAR UPPER):

Two (2) Tecniq Model K60-R*00-1 Red LED warning lightsshall be mounted on the upper rear area of the vehicle. These lights shall be switched from the in cab switch panel. The lights fill the requirements of Zone C Upper.

Each light shall be mounted utilizing a chrome plated flange.

Each light shall incorporate a colored lens.

WARNING LIGHTS (REAR):

Two (2) Tecniq Model K60-R*00-1 Red LED warning lights shall be mounted on the lower rear area of the vehicle. These lights shall be switched from the in cab switch panel. These lights fill the requirements of Zone C Lower.

Each light shall be mounted utilizing a chrome plated flange.

Each light shall incorporate a colored lens.

REAR DRIVING SIGNALS:

The rear driving signals shall consist of two (2) Code 3 7X9STTRBZ LED lights, one (1) each side of

the apparatus at the rear. The 7X9 LED lights shall incorporate red brake/tail, amber turn, and white backup in a single light head. The mounting shall include a chrome bezel.

ELECTRONIC SIREN:

One (1) Whelen Model 295SLSA1 siren shall be installed in the apparatus. The siren shall be mounted in the cab and shall include a noise-canceling microphone.

SIREN SPEAKER:

One (1) Whelen Model SA315 100 watt siren speaker shall be installed in the apparatus bumper.

BACKUP ALARM:

One (1) 12 volt electronic backup alarm shall be incorporated on the apparatus. The backup alarm shall be a minimum of 97db and switched with the backup light circuitry.

ICC LIGHTING:

Tecniq S34 Series LED Clearance lights shall be installed on the apparatus. They shall be hermetically sealed cartridge lights for ease of service and durability.

LED REAR LICENSE PLATE BRACKET:

There shall be a Cast Products LED license plate bracket provided at the rear of the apparatus.

HAZARD LIGHT:

A red, LED flashing light located in the driving compartment shall be illuminated automatically whenever the apparatus parking brake is not fully engaged and any passenger or equipment compartment door is open, any ladder or equipment rack is not in the stowed position, a stabilizer system is deployed, a powered light tower is extended, or any other device is opened, extended, or deployed that creates a hazard or is likely to cause damage to the apparatus if the apparatus is moved. The light shall be marked "Do Not Move Apparatus When Light Is On".

LED COURTESY LIGHTS (UNDER CARRIAGE LIGHTING):

One (1) 5" 12-volt T44 Series LED light shall be located under each cab door and one (1) shall be located below the rear tail step in the center. All ground area lighting shall be controlled by the master switch and shall be switched with the parking brake.

In addition to the 5" lights, clear LED strip lights shall be provided integral to the rub rails on each side. The strip lights shall face downward and be activated with the balance of the undercarriage lighting.

LED REAR BUMPER COURTESY LIGHTS:

Two (2) S34 Series LED courtesy lights shall be mounted one (1) each side low on the rear panel. The lights shall illuminate the rear tailboard. They shall be switched with the parking brake.

HOSEBED STRIP LIGHTING - LED:

Two (2) E45 Series LED Strip lights shall be provided at the front of the apparatus hose bed. The lights shall be switched with the parking brake.

BACK-UP CAMERA INSTALLATION:

The chassis supplied back-up camera shall be installed in the rear body panel, above the rear compartment door.

BRACKETING:

FOLDING STEPS:

Four (4) large folding steps shall be furnished on the apparatus.

Location: Two (2) each side at the rear tail step area.

Each folding step shall have a chrome finish

GRAB HANDLES:

Two (2) 18" knurled bright stainless steel 1¼" O.D. grab rails shall be installed vertically at the rear of the apparatus.

Each grab handle shall have a natural stainless steel finish

GRAB HANDLE:

One (1) 48" knurled bright stainless steel 1¼" O.D. grab rail shall be installed horizontally below the apparatus hose bed.

Each grab handle shall have a natural stainless steel finish

GRAB HANDLES:

Two (2) 12" knurled bright stainless steel 1¼" O.D. grab handles shall be installed at the on the top of the compartments at the rear of the apparatus, one (1) each side.

HARD SUCTION HOSE STORAGE- LEFT SIDE:

One (1) hard suction hose storage compartment shall be designed into the left upper compartment area. The suction hose shall be accessible from the rear of the apparatus through a drop down door with a single point latch. The door shall be manufactured of the same material as the rear body panel and finished to match (treadplate, painted, chevron, etc.) The suction hose compartment shall be an integral part of the compartment area.

The compartment shall have the capacity to contain two (2) lengths of suction hose.

LADDER STORAGE:

A ladder storage area shall be provided above the right side compartments. The ladder storage area shall be recessed below the roof of the apparatus and incorporate an open top. Straps shall be provided to secured the ladder in its travel position. The ladder shall be stored horizontally.

The ladder storage area shall have the capacity to carry:

One (1) 14' 2-Section Ladder

One (1) 8' Attic Ladder

One (1) Pike Pole(s)

FINISH:

APPARATUS BODY FINISH:

The final finish of the apparatus shall conform to fire apparatus standards, exhibiting excellent gloss durability and color retention properties.

PREPARATION:

Since the removal of all contaminants and oxidation is essential to the final effect of a finish system, the apparatus shall be pre-cleaned with wax and grease remover and towel dried prior to evaporation.

A 10-step standard body preparation shall be completed.

When the substrate is prepared, the entire body shall be cleaned by washing again with wax and grease remover and towel dried.

PRETREAT AND PRIMERS:

The pretreat and primer applications shall be made in two (2) independent steps. A application of a combined pretreat/primer product will not be allowed as a substitute.

The prepared substrate shall be pretreated with Acid Curing 2 Component Transparent Primer. This pretreat shall be designed to provide corrosion protection and to create an adhesive bond between the substrate and the surface applications.

To enhance adhesion and top coat gloss, a 2 component epoxy primer shall be applied.

All the primed surfaces shall be sanded smooth, thus removing all texture and surface imperfections and creating a finish base that will meet the rigid requirements of the fire and emergency services.

TOP COATS:

Two (2) coats (0.5 - 2.0 mils) urethane base coat shall be applied in a professional manner. After the base coats have cured properly, two (2) coats of a high solids urethane clear coat shall be applied.

All surface imperfections shall be removed by buffing and polishing.

PAINT WARRANTY:

The apparatus shall be covered by a five (5) year paint warranty.

Following are the covered defects and exclusions.

Covered Defects shall include only the following list of defects:

- Peeling or delaminating of the topcoat and/or other layers of paint.
- Cracking or checking.

- Loss of gloss caused by cracking, checking or hazing.

Defects resulting from the following conditions are excluded from the Warranty:

- Hazing, chalking or loss of gloss caused by improper care, abrasive polishes, cleaning agents, heavy-duty pressure washing, or aggressive mechanical wash systems
- Rock chips are not covered under this warranty.
- Paint deteriorating caused by abuse, scratches, chips, gloss reduction, accidents, acid rain, chemical fallout or acts of nature
- Claims presented without proper Warranty documentation
- Failure on finishes performed by Non-PPG Commercial Certified Technicians
- Failures on finishes due to inadequate film builds
- Failures due to improper cleaning or surface preparation or failure to follow the product use instructions

BODY UNDERCOATING:

The apparatus body assemblies shall be undercoated.

The hose bed interior walls shall remain natural finish.

COMPARTMENT INTERIOR FINISH:

The interior of the compartments shall be natural finish aluminum

APPARATUS COLOR:

The color of the apparatus shall be as follows:

COLOR: _____

CAB LETTERING:

Vinyl lettering as described below shall be applied to the chassis cab door, one (1) each side. Each letter shall be 2½" to 3½" high and hand applied.

Vinyl letters/numbers shall be applied to the chassis cab fender area, one (1) each side. Each letter/number shall be 2½" to 3½" high and hand applied.

The lettering vinyl style shall be simulated gold leaf.



The lettering font style shall be Eurostile Bold.

The lettering font highlight type shall be shadow.

LAMINATION WARRANTY:

The apparatus shall be covered by a two (2) year warranty against defects in material and workmanship with the graphics process

REFLECTIVE STRIPING:

The finished apparatus shall be striped with 4" reflective Scotchlite striping.

The reflective striping shall be white in color.

REFLECTIVE STRIPING IN THE CAB:

Two-inch red and white striped retro-reflective material shall be placed on the inside of each opening cab door. The material will be at least 96 square inches, meeting current NFPA standards.

DIAMOND GRADE CHEVRON STRIPING:

The rear of the apparatus shall be striped with Diamond Grade retro-reflective striping. The striping shall be applied in a chevron pattern sloping downward and away from the centerline of the apparatus at a 45° angle. The striping shall be single color alternating between red #3992 and fluorescent yellow-green #3983.

The Chevron striping shall be applied in the following locations: vertical surfaces of the body at the rear, outboard of the rear compartment door.

EQUIPMENT:

One (1) Duo-Safety #8-585A aluminum folding 8' attic ladder(s).

One (1) Duo-Safety #14-1000A, 14' 2 Section ground ladder(s).

Two (2) 8' Length(s) of 6" diameter hard suction hose, coupled 6" LHF x 6" RLM. (Not rated for hydrants)



NFPA EQUIPMENT CLARIFICATION:

Any equipment specified in the “Minor Equipment” section (e.g. hose, nozzles, adapters, AED, traffic cones, traffic safety vests, etc.) of NFPA 1901 for each apparatus classification (see below) which is not specified in this proposal shall be considered to be customer supplied and installed.

Apparatus Type	NFPA Section
Pumper	5.8
Initial Attack	6.7
Mobile Water Supply	7.7
Aerial	8.8
Quint	9.8
Special Service	10.5
Mobile Foam	11.9



HOSE CAPACITIES

DWG NO. MP1-A17-2
10/31/2023

Customer Alexis Fire Equipment Co
Calculated By M. Tinkham

Contract No. 2542
Rev. No. 01 MLT

HOSE BED		Hose	
Length	<u>81</u>	Size	
Width	<u>48</u>	Amount	
Height	<u>22</u>	DF	0 0 0 0 0
Cu. Ft.	49.50 0.00	Cu. Ft.	0.00 0.00 0.00 0.00 0.00
Total <u>49.50</u>		Total Need <u>0.00</u>	

MATTYDALES		Hose	
Length	<u>73</u> <u>73</u>	Size	<u>2 1/2</u> <u>1 3/4</u>
Width	<u>7</u> <u>7</u>	Amount	<u>150</u> <u>200</u>
Height	<u>15</u> <u>15</u>	DF	41 26 0
Cu. Ft.	4.44 4.44 0.00	Cu. Ft.	3.56 3.01 0.00
Total <u>8.87</u>		Total <u>6.57</u>	

CARTRIDGE LAYS		Hose	
Length		Size	
Width		Amount	
Height		DF	0 0 0
Cu. Ft.	0.00 0.00 0.00	Cu. Ft.	0.00 0.00 0.00
Total <u>0.00</u>		Total <u>0.00</u>	

HOSE TRAYS		Hose	
Length		Size	
Width		Amount	
Height		DF	0 0 0
Cu. Ft.	0.00 0.00 0.00	Cu. Ft.	0.00 0.00 0.00
Total <u>0.00</u>		Total <u>0.00</u>	

HOSE WELLS		Hose	
Length		Size	
Width		Amount	
Height		DF	0 0 0
Cu. Ft.	0.00 0.00 0.00	Cu. Ft.	0.00 0.00 0.00
Total <u>0.00</u>		Total <u>0.00</u>	

Standard Hose Dimensions per NFPA (2003 Edition)

1 3/4" lays 3 1/4" wide	DF=	26	1" FORESTRY lays 1 3/4" wide	DF=	10
2" (ANGUS) lays 3 3/4" wide	DF=	24	1 1/2" FORESTRY 2 1/2" wide	DF=	14
2 1/2" lays 4 1/2" wide	DF=	41			
3" lays 5 1/4" wide	DF=	50			
4" lays 6 1/2" wide	DF=	58			
5" lays 8" wide - Angus	DF=	96			
5" lays 8-1/2" wide - Cotton	DF=	102			
6" lays 9 1/2" wide	DF=	108			

2023 F-550 Chassis 4x4 SD Crew Cab 203" WB DRW XL (W5H)

Price Level: 340



Client Proposal

Prepared by:

Ed Miller

Office: 713-678-5007

Email: EMILLER@CHASTANGFORD.COM

Quote ID: alex24w5h

Date: 06/09/2023



Chastang Ford | 6200 N. Loop East, Houston, Texas, 770261936

Office: 713-678-5000 | Fax: 713-678-5001



Prepared by: Ed Miller

06/09/2023

Chastang Ford | 6200 N. Loop East Houston Texas | 770261936

2023 F-550 Chassis 4x4 SD Crew Cab 203" WB DRW XL (W5H)

Quote ID: alex24w5h

As Configured Vehicle

Code	Description	MSRP
Base Vehicle		
W5H	Base Vehicle Price (W5H)	\$57,870.00
Packages		
660A	Order Code 660A <i>Includes:</i> - Transmission: TorqShift 10-Speed Automatic 10R140 with neutral idle. Includes SelectShift and selectable drive modes: normal, tow/haul, eco, slippery roads and off-road. - Wheels: 19.5" x 6" Argent Painted Steel Hub covers/center ornaments not included. - HD Vinyl 40/20/40 Split Bench Seat Includes center armrest, cupholder, storage, 2-way adjustable driver/passenger headrests and driver's side manual lumbar. - Radio: AM/FM Stereo w/MP3 Player Includes 6 speakers. - SYNC 4 Communications & Entertainment System Includes enhanced voice recognition, 911 Assist, 8" LCD center stack screen, AppLink, 1 smart-charging USB port and trailer brake controller.	N/C
Powertrain		
99T	Engine: 6.7L 4V OHV Power Stroke V8 Turbo Diesel B20 <i>Includes Operator Commanded Regeneration (OCR), Diesel Exhaust Fluid (DEF) tank, intelligent oil-life monitor and manual push-button engine-exhaust braking.</i>	\$9,995.00
44G	Transmission: TorqShift 10-Speed Automatic <i>10R140 with neutral idle. Includes SelectShift and selectable drive modes: normal, tow/haul, eco, slippery roads and off-road.</i>	Included
X4L	Limited Slip w/4.30 Axle Ratio	\$395.00
68M	GVWR: 19,500 lb Payload Plus Upgrade Package <i>Includes upgraded frame, rear-axle and low deflection/high capacity rear springs. Increases max RGAWR to 14,706 lbs. Note: See Order Guide Supplemental Reference for further details on GVWR.</i>	\$1,155.00
Wheels & Tires		
TGK	Tires: 225/70Rx19.5G BSW Traction (TGK) <i>Includes 4 traction tires on the rear and 2 traction tires on the front. Not recommended for over the road applications; could incur irregular front tire wear and/or NVH.</i>	\$215.00

Prices and content availability as shown are subject to change and should be treated as estimates only. Actual base vehicle, package and option pricing may vary from this estimate because of special local pricing, availability or pricing adjustments not reflected in the dealer's computer system. See salesperson for the most current information.

Note: Prices and content availability as shown are subject to change and should be treated as estimates only. Actual base vehicle, package and option pricing may vary from this estimate because of special local pricing, availability or pricing adjustments not reflected in the dealer's computer system. See salesperson for the most current information.



Prepared by: Ed Miller

06/09/2023

Chastang Ford | 6200 N. Loop East Houston Texas | 770261936

2023 F-550 Chassis 4x4 SD Crew Cab 203" WB DRW XL (W5H)

Quote ID: alex24w5h

As Configured Vehicle (cont'd)

Code	Description	MSRP
64Z	Wheels: 19.5" x 6" Argent Painted Steel <i>Hub covers/center ornaments not included.</i>	Included
Seats & Seat Trim		
A	HD Vinyl 40/20/40 Split Bench Seat <i>Includes center armrest, cupholder, storage, 2-way adjustable driver/passenger headrests and driver's side manual lumbar.</i>	Included
Other Options		
PAINT	Monotone Paint Application	STD
203WB	203" Wheelbase	STD
STDRD	Radio: AM/FM Stereo w/MP3 Player <i>Includes 6 speakers.</i> <i>Includes:</i> - SYNC 4 Communications & Entertainment System <i>Includes enhanced voice recognition, 911 Assist, 8" LCD center stack screen, AppLink, 1 smart-charging USB port and trailer brake controller.</i>	Included
96V	XL Chrome Package <i>Includes:</i> - Chrome Front Bumper - Bright Grille - Power Sliding Rear Glass - Rear Window Defroster - Remote Start - Halogen Fog Lamps	\$225.00
67P	Extra Heavy-Duty Front End Suspension - 7,500 GAWR <i>Includes upgraded front axle and max 7,500 lbs. Front springs/GAWR rating for configuration selected. Incomplete vehicle package - requires further manufacture and certification by a final stage manufacturer.</i>	\$285.00
535	High Capacity Trailer Tow Package <i>Includes trailer brake wiring kit and upgraded rear axle. Increases GCW from 32,500 lbs. to 40,000 lbs. Note: Salesperson's Portfolio or Trailer Towing Guide should be consulted for specific trailer towing or camper limits and corresponding required equipment, axle ratios and model availability. See Supplemental Reference for vehicle height consideration</i>	\$580.00
41H	Engine Block Heater	\$100.00
67B	410 Amp Dual Alternators <i>Includes 250 Amp + 160 Amp.</i>	\$115.00

Prices and content availability as shown are subject to change and should be treated as estimates only. Actual base vehicle, package and option pricing may vary from this estimate because of special local pricing, availability or pricing adjustments not reflected in the dealer's computer system. See salesperson for the most current information.

Note: Prices and content availability as shown are subject to change and should be treated as estimates only. Actual base vehicle, package and option pricing may vary from this estimate because of special local pricing, availability or pricing adjustments not reflected in the dealer's computer system. See salesperson for the most current information.



Prepared by: Ed Miller

06/09/2023

Chastang Ford | 6200 N. Loop East Houston Texas | 770261936

2023 F-550 Chassis 4x4 SD Crew Cab 203" WB DRW XL (W5H)

Quote ID: alex24w5h

Selected Equip & Specs

Dimensions

- Conventional Capacity: 18,500 lbs.
- * **Fifth-wheel towing capacity: 33,100 lbs.**
- Vehicle body length: 289.2"
- Vehicle body height: 81.7"
- Front track: 74.8"
- Vehicle turning radius: 28.6'
- Rear tire outside width: 93.9"
- Frame section modulus: 12.7 cu.in.
- Frame rail width: 34.2"
- Front bumper to back of cab: 158.1"
- Rear brake diameter: 15.8"
- Max interior rear cargo volume: 52.1 cu.ft.
- Headroom first-row: 40.8"
- Leg room first-row: 43.9"
- Shoulder room first-row: 66.7"
- Hip room first-row: 62.5"
- * **GCWR: 43,000 lbs.**
- * **Gooseneck towing capacity: 33,300 lbs.**
- Vehicle body width: 80.0"
- Wheelbase: 203.0"
- Rear track: 74.0"
- Cab to axle: 84.0"
- Axle to end of frame: 47.2"
- Frame yield strength (psi): 50000.0
- Front bumper to front axle: 38.3"
- Front brake diameter: 15.4"
- Interior rear cargo volume with seats folded: 52.1 cu.ft.
- Total passenger volume: 131.7 cu.ft.
- Headroom second-row: 40.4"
- Leg room second-row: 43.6"
- Shoulder room second-row: 65.9"
- Hip room second-row: 64.7"

Powertrain

- * **Powerstroke 6.7L V-8 diesel direct injection, DEVCT intercooled turbo, diesel, engine with 330HP**
- * **Compression ignition system**
- * **Torque: 950 lb.-ft.@1800 RPM**
- Radiator
- * **Engine retarder system**
- Part-time 4WD
- * **Recommended fuel: diesel**
- Driveline managed traction control
- Electronic transfer case shift
- Engine cylinders: V-8
- * **Horsepower: 330 HP@2200 RPM**
- * **Engine block heater**
- Auxiliary power take-off
- TorqShift 10-speed automatic
- Four-wheel drive
- * **Mechanical limited slip differential**
- Auto locking hub control

Fuel Economy and Emissions

- * **Diesel secondary fuel type**
- Federal emissions

Suspension and Handling

- Firm ride suspension
- Heavy-duty front shock absorbers

Prices and content availability as shown are subject to change and should be treated as estimates only. Actual base vehicle, package and option pricing may vary from this estimate because of special local pricing, availability or pricing adjustments not reflected in the dealer's computer system. See salesperson for the most current information.

Note: Prices and content availability as shown are subject to change and should be treated as estimates only. Actual base vehicle, package and option pricing may vary from this estimate because of special local pricing, availability or pricing adjustments not reflected in the dealer's computer system. See salesperson for the most current information.



Prepared by: Ed Miller

06/09/2023

Chastang Ford | 6200 N. Loop East Houston Texas | 770261936

2023 F-550 Chassis 4x4 SD Crew Cab 203" WB DRW XL (W5H)

Quote ID: alex24w5h

Selected Equip & Specs (cont'd)

- Heavy-duty rear shock absorbers

Driveability

- 4-wheel disc brakes
- 4-wheel antilock (ABS) brakes
- Brake assist system
- Mono-beam rigid axle front suspension
- Front coil springs
- Leaf spring rear suspension
- Hydraulic power-assist steering system
- 2-wheel steering system
- Front and rear ventilated disc brakes
- Four channel ABS brakes
- Hill Start Assist
- Front anti-roll bar
- * **Rigid axle rear suspension**
- Rear anti-roll bar
- Re-circulating ball steering

Body Exterior

- Trailer wiring harness
- Clearcoat paint
- Black fender flares
- Black windshield trim
- * **Chrome front bumper**
- 2 front tow hooks
- Black door mirrors
- Convex spotter in driver and passenger side door mirrors
- Conventional left rear passenger door
- * **LT225/70RS19.5 AT BSW front and rear tires**
- 4 doors
- Monotone paint
- Black side window trim
- Black door handles
- * **Body-coloured front bumper rub strip**
- * **Black grille with chrome accents**
- Manual extendable trailer mirrors
- Turn signal indicator in door mirrors
- Conventional right rear passenger door
- 19.5 x 6-inch front and dual rear argent steel wheels

Convenience

- Power door locks with 2 stage unlocking
- All-in-one remote fob and ignition key
- * **FordPass Connect smart device and keyfob vehicle start control**
- Power first-row windows
- * **Power rear windshield**
- Illuminated glove box
- Rear beverage holders
- Instrument panel covered bin
- Retained accessory power
- Trip computer
- Over the air updates
- Keyfob activated door locks
- Cruise control with steering wheel mounted controls
- Day/Night rearview mirror
- * **Rear window defroster**
- Illuminated locking glove box
- Front beverage holders
- 8 beverage holders
- Dashboard storage
- PRND in IP
- Upfitter switches

Prices and content availability as shown are subject to change and should be treated as estimates only. Actual base vehicle, package and option pricing may vary from this estimate because of special local pricing, availability or pricing adjustments not reflected in the dealer's computer system. See salesperson for the most current information.

Note: Prices and content availability as shown are subject to change and should be treated as estimates only. Actual base vehicle, package and option pricing may vary from this estimate because of special local pricing, availability or pricing adjustments not reflected in the dealer's computer system. See salesperson for the most current information.



Prepared by: Ed Miller

06/09/2023

Chastang Ford | 6200 N. Loop East Houston Texas | 770261936

2023 F-550 Chassis 4x4 SD Crew Cab 203" WB DRW XL (W5H)

Quote ID: alex24w5h

Selected Equip & Specs (cont'd)

Comfort

- Manual climate control
- Rear under seat climate control ducts
- Full headliner coverage
- Full floor coverage
- Carpet rear seatback upholstery
- Manual telescopic steering wheel
- Cabin air filter
- Cloth headliner material
- Full vinyl floor covering
- Vinyl rear seat upholstery
- Manual tilting steering wheel
- Urethane steering wheel

Seats and Trim

- Seating capacity: 6
- Split-bench front seat
- Front passenger seat with 4-way directional controls
- Manual front seat head restraint control
- Front seat armrest storage
- Manual driver seat fore/aft control
- Manual passenger seat fore/aft control
- Split-bench rear seat
- Manual driver seat lumbar
- 40-20-40 split-bench front seat
- Driver seat with 4-way directional controls
- Height adjustable front seat head restraints
- Front seat center armrest
- Manual reclining driver seat
- Manual reclining passenger seat
- Fixed rear seats
- Height adjustable rear seat head restraints
- Vinyl front seat upholstery

Entertainment Features

- 2 total number of 1st row displays
- Primary touchscreen display
- Seek scan
- Speakers number: 6
- Steering wheel mounted audio controls
- Speed sensitive volume
- Fixed audio antenna
- 8 inch primary LCD display
- AM/FM stereo radio
- SYNC 4 external memory control
- Standard grade speakers
- SYNC 4 voice activated audio controls
- Wireless audio streaming

Lighting, Visibility and Instrumentation

- Digital/analog instrumentation display
- Trip odometer
- Compass
- Driver information center
- Tachometer
- * **Turbo/supercharger boost gauge**
- Engine hour meter
- Light tinted windows
- Halogen headlights
- Configurable instrumentation gauges
- In-radio display clock
- Exterior temperature display
- Gauge cluster display size (inches): 4.20
- Engine/electric motor temperature gauge
- Transmission fluid temperature gauge
- * **Diesel exhaust fluid (def) gauge**
- Aero-composite headlights
- Autolamp auto on/off headlight control

Prices and content availability as shown are subject to change and should be treated as estimates only. Actual base vehicle, package and option pricing may vary from this estimate because of special local pricing, availability or pricing adjustments not reflected in the dealer's computer system. See salesperson for the most current information.

Note: Prices and content availability as shown are subject to change and should be treated as estimates only. Actual base vehicle, package and option pricing may vary from this estimate because of special local pricing, availability or pricing adjustments not reflected in the dealer's computer system. See salesperson for the most current information.



Prepared by: Ed Miller

06/09/2023

Chastang Ford | 6200 N. Loop East Houston Texas | 770261936

2023 F-550 Chassis 4x4 SD Crew Cab 203" WB DRW XL (W5H)

Quote ID: alex24w5h

Selected Equip & Specs (cont'd)

- Multiple enclosed headlights
- DRL preference setting
- Front reading lights
- Rear reading lights
- Daytime running lights
- Cab clearance lights
- Fade interior courtesy lights
- Delay-off headlights
- Variable intermittent front windshield wipers
- Illuminated entry
- Variable instrument panel light
- * **Front fog lights**
- Remote activated perimeter approach lighting

Technology and Telematics

- SYNC 4 911 Assist emergency SOS system via mobile device
- AppLink/Apple CarPlay and Android Auto smart device wireless mirroring
- 2 USB ports
- SYNC 4 handsfree wireless device connectivity
- FordPass Connect 4G mobile hotspot internet access

Safety and Security

- Driver front impact airbag
- Safety Canopy System curtain first and second-row overhead airbags
- Seat mounted side impact front passenger airbag
- Front height adjustable seatbelts
- Remote panic alarm
- Pre-Collision Assist with Automatic Emergency Braking (AEB) forward collision mitigation
- Seat mounted side impact driver airbag
- Passenger front impact airbag
- 6 airbags
- SecuriLock immobilizer
- Lane Departure Warning
- Manual rear child safety door locks

Dimensions

General Weights

* Curb weight	8,436 lbs.	* Rear curb weight	3,431 lbs.
* GVWR	19,500 lbs.	* Payload	11,150 lbs.

Trailer Weights

* Fifth-wheel towing capacity	33,100 lbs.	* Gooseneck towing capacity	33,300 lbs.
Conventional capacity	18,500 lbs.	* GCWR	43,000 lbs.

Front Weights

* Front curb weight	5,005 lbs.	* GAWR front	7,500 lbs.
* Axle capacity front	7,500 lbs.	* Spring rating front	7,500 lbs.
Tire/wheel capacity front	7,500 lbs.		

Prices and content availability as shown are subject to change and should be treated as estimates only. Actual base vehicle, package and option pricing may vary from this estimate because of special local pricing, availability or pricing adjustments not reflected in the dealer's computer system. See salesperson for the most current information.

Note: Prices and content availability as shown are subject to change and should be treated as estimates only. Actual base vehicle, package and option pricing may vary from this estimate because of special local pricing, availability or pricing adjustments not reflected in the dealer's computer system. See salesperson for the most current information.



Prepared by: Ed Miller

06/09/2023

Chastang Ford | 6200 N. Loop East Houston Texas | 770261936

2023 F-550 Chassis 4x4 SD Crew Cab 203" WB DRW XL (W5H)

Quote ID: alex24w5h

Selected Equip & Specs (cont'd)

Rear Weights

* GAWR rear	14,706 lbs.	* Axle capacity rear	14,706 lbs.
* Spring rating rear	14,706 lbs.	Tire/wheel capacity rear	15,000 lbs.

Off Road

Min ground clearance	8.2"
----------------------------	------

Exterior Measurements

Vehicle body length	289.2"	Vehicle body width	80.0"
Vehicle body height	81.7"	Wheelbase	203.0"
Front brake diameter	15.4"	Rear brake diameter	15.8"
Rear frame height loaded	28.6"	Rear frame height unloaded	34.3"
Front track	74.8"	Rear track	74.0"
Vehicle turning radius	28.6'	Cab to axle	84.0"
Rear tire outside width	93.9"	Axle to end of frame	47.2"
Frame section modulus	12.7 cu.in.	Frame yield strength (psi)	50000.0
Frame rail width	34.2"	Front bumper to front axle	38.3"
Front bumper to back of cab	158.1"		

Interior Measurements

Max interior rear cargo volume	52.1 cu.ft.	Interior rear cargo volume with seats folded	52.1 cu.ft.
--------------------------------------	-------------	--	-------------

Interior Volume

Total passenger volume	131.7 cu.ft.
------------------------------	--------------

Headroom

Headroom first-row	40.8"	Headroom second-row	40.4"
--------------------------	-------	---------------------------	-------

Legroom

Leg room first-row	43.9"	Leg room second-row	43.6"
--------------------------	-------	---------------------------	-------

Shoulder Room

Shoulder room first-row	66.7"	Shoulder room second-row	65.9"
-------------------------------	-------	--------------------------------	-------

Hip Room

Hip room first-row	62.5"	Hip room second-row	64.7"
--------------------------	-------	---------------------------	-------

Powertrain

Engine

Prices and content availability as shown are subject to change and should be treated as estimates only. Actual base vehicle, package and option pricing may vary from this estimate because of special local pricing, availability or pricing adjustments not reflected in the dealer's computer system. See salesperson for the most current information.

Note: Prices and content availability as shown are subject to change and should be treated as estimates only. Actual base vehicle, package and option pricing may vary from this estimate because of special local pricing, availability or pricing adjustments not reflected in the dealer's computer system. See salesperson for the most current information.



Prepared by: Ed Miller

06/09/2023

Chastang Ford | 6200 N. Loop East Houston Texas | 770261936

2023 F-550 Chassis 4x4 SD Crew Cab 203" WB DRW XL (W5H)

Quote ID: alex24w5h

Selected Equip & Specs (cont'd)

* Engine **Powerstroke 6.7L V-8 diesel direct injection, DEVCT intercooled turbo, diesel, engine with 330HP**

Engine cylinders V-8

* Ignition **Compression ignition system**

Engine block material Iron engine block

Engine Specs

* Displacement **6.7L**

* Bore **3.9"**

* Compression ratio **15.2**

Engine Power

* Horsepower **330 HP@2200 RPM**

Alternator

Alternator amps 250A

* Alternator rating **160A**

Battery

Battery amps 78Ah

Battery rating 750CCA

Engine Extras

* **Block heater** **Engine block heater**

Auxiliary power take-off Auxiliary power take-off

Transmission

Transmission TorqShift 10-speed automatic

Overdrive transmission Overdrive transmission

First gear ratio 4.615

Third gear ratio 2.132

Fifth gear ratio 1.519

Reverse gear ratio 4.695

Eighth gear ratio 0.851

Tenth gear ratio 0.632

Selectable mode transmission Selectable mode transmission

* Valves per cylinder **4**

Engine location Front mounted engine

Engine mounting direction Longitudinal mounted engine

Cylinder head material Aluminum cylinder head

* cc **405.9 cu.in.**

* Stroke **4.25"**

SAEJ1349 AUG2004 compliant

* Torque **950 lb.-ft.@1800 RPM**

* Alternator type **Dual alternator**

Battery type HD lead acid battery

Battery run down protection Battery run down protection

Radiator Radiator

* **Engine retarder** **Engine retarder system**

Transmission electronic control Transmission electronic control

Lock-up transmission Lock-up transmission

Second gear ratio 2.919

Fourth gear ratio 1.773

Sixth gear ratio 1.277

Seventh gear ratio 1

Ninth gear ratio 0.687

Stall ratio 1.97

Sequential shift control SelectShift Sequential shift control

Prices and content availability as shown are subject to change and should be treated as estimates only. Actual base vehicle, package and option pricing may vary from this estimate because of special local pricing, availability or pricing adjustments not reflected in the dealer's computer system. See salesperson for the most current information.

Note: Prices and content availability as shown are subject to change and should be treated as estimates only. Actual base vehicle, package and option pricing may vary from this estimate because of special local pricing, availability or pricing adjustments not reflected in the dealer's computer system. See salesperson for the most current information.



Prepared by: Ed Miller

06/09/2023

Chastang Ford | 6200 N. Loop East Houston Texas | 770261936

2023 F-550 Chassis 4x4 SD Crew Cab 203" WB DRW XL (W5H)

Quote ID: alex24w5h

Selected Equip & Specs (cont'd)

Transmission oil cooler	Transmission oil cooler	PTO transmission provision	PTO transmission provision
<i>Drive Type</i>			
4WD type	Part-time 4WD	Drive type	Four-wheel drive
<i>Drivetrain</i>			
* Axle ratio	4.3		
<i>Exhaust</i>			
Tailpipe	Stainless steel single exhaust		
<i>Fuel</i>			
* Fuel type	diesel		
<i>Fuel Tank</i>			
* DEF capacity	7.20 gal.	Fuel tank capacity	40.00 gal.
<i>Drive Feature</i>			
* Limited slip differential	Mechanical limited slip differential	Traction control	Driveline managed traction control
Locking hub control	Auto locking hub control	Transfer case	Electronic transfer case shift

Fuel Economy and Emissions

<i>Fuel Economy</i>	
* Secondary fuel type	Diesel secondary fuel type
<i>Emissions</i>	
Emissions	Federal emissions

Suspension and Handling

<i>Suspension</i>		
Suspension	Firm ride suspension	Front shock absorbers
Rear shock absorbers	Heavy-duty rear shock absorbers	Heavy-duty front shock absorbers

Driveability

Brakes

Prices and content availability as shown are subject to change and should be treated as estimates only. Actual base vehicle, package and option pricing may vary from this estimate because of special local pricing, availability or pricing adjustments not reflected in the dealer's computer system. See salesperson for the most current information.

Note: Prices and content availability as shown are subject to change and should be treated as estimates only. Actual base vehicle, package and option pricing may vary from this estimate because of special local pricing, availability or pricing adjustments not reflected in the dealer's computer system. See salesperson for the most current information.



Prepared by: Ed Miller

06/09/2023

Chastang Ford | 6200 N. Loop East Houston Texas | 770261936

2023 F-550 Chassis 4x4 SD Crew Cab 203" WB DRW XL (W5H)

Quote ID: alex24w5h

Selected Equip & Specs (cont'd)

Brake type	4-wheel disc brakes	Ventilated brakes	Front and rear ventilated disc brakes
ABS brakes	Four channel ABS brakes	ABS brakes	4-wheel antilock (ABS) brakes
<i>Brake Assistance</i>			
Hill start assist	Hill Start Assist	Brake assist system	Brake assist system
<i>Front Suspension</i>			
Anti-roll bar front	Front anti-roll bar	Suspension ride type front	Mono-beam rigid axle front suspension
<i>Front Spring</i>			
* HD front springs	Heavy-duty front springs	Springs front	Front coil springs
<i>Rear Spring</i>			
Springs rear	Rear leaf springs	Rear springs	Heavy-duty rear springs
<i>Rear Suspension</i>			
Anti-roll bar rear	Rear anti-roll bar	Suspension type rear	Leaf spring rear suspension
* Suspension ride type rear	Rigid axle rear suspension		
<i>Steering</i>			
Steering system	Hydraulic power-assist steering system	Steering type	Re-circulating ball steering
Steering type number of wheels	2-wheel steering system		

Exterior

Front Wheels

Front wheels diameter 19.5" Front wheels width 6"

Rear Wheels

Rear wheels diameter 19.5" Rear wheels width 6"

Front And Rear Wheels

Appearance argent Material steel

Front Tires

Aspect	70	Diameter	19.5"
Sidewalls	BSW	Speed	S
* Tread	AT	Type	LT

Prices and content availability as shown are subject to change and should be treated as estimates only. Actual base vehicle, package and option pricing may vary from this estimate because of special local pricing, availability or pricing adjustments not reflected in the dealer's computer system. See salesperson for the most current information.

Note: Prices and content availability as shown are subject to change and should be treated as estimates only. Actual base vehicle, package and option pricing may vary from this estimate because of special local pricing, availability or pricing adjustments not reflected in the dealer's computer system. See salesperson for the most current information.



Prepared by: Ed Miller

06/09/2023

Chastang Ford | 6200 N. Loop East Houston Texas | 770261936

2023 F-550 Chassis 4x4 SD Crew Cab 203" WB DRW XL (W5H)

Quote ID: alex24w5h

Selected Equip & Specs (cont'd)

Width	225mm	* Front wheel - RPM	645
<i>Rear Tires</i>			
Aspect	70	Diameter	19.5"
Sidewalls	BSW	Speed	S
* Tread	AT	Type	LT
Width	225mm	* Rear wheel - RPM	645

Body Exterior

Trailerling

Towing wiring harness	Trailer wiring harness	Towing brake controller	Trailer brake controller
Towing trailer sway	Trailer sway control		

Exterior Features

Number of doors	4 doors	Front splash guards	Front splash guards
-----------------------	---------	---------------------------	---------------------

Body

Body panels .. Aluminum body panels with side impact beams

Mirrors

Convex spotter	Convex spotter in driver and passenger side door mirrors	Turn signal in door mirrors	Turn signal indicator in door mirrors
----------------------	--	-----------------------------------	---------------------------------------

Tires

Front tires LT load rating	G	Rear tires LT load rating	G
----------------------------------	---	---------------------------------	---

Wheels

Dual rear wheels

Convenience

Door Locks

Door locks	Power door locks with 2 stage unlocking	Keyfob door locks	Keyfob activated door locks
All-in-one key	All-in-one remote fob and ignition key		

Cruise Control

Cruise control

Key Fob Controls

Prices and content availability as shown are subject to change and should be treated as estimates only. Actual base vehicle, package and option pricing may vary from this estimate because of special local pricing, availability or pricing adjustments not reflected in the dealer's computer system. See salesperson for the most current information.

Note: Prices and content availability as shown are subject to change and should be treated as estimates only. Actual base vehicle, package and option pricing may vary from this estimate because of special local pricing, availability or pricing adjustments not reflected in the dealer's computer system. See salesperson for the most current information.



Prepared by: Ed Miller

06/09/2023

Chastang Ford | 6200 N. Loop East Houston Texas | 770261936

2023 F-550 Chassis 4x4 SD Crew Cab 203" WB DRW XL (W5H)

Quote ID: alex24w5h

Selected Equip & Specs (cont'd)

* **Fob remote vehicle controls** **FordPass**
Connect smart device and keyfob vehicle
start control

Rear View Mirror

Day/Night rearview mirror Day/Night rearview
mirror

Exterior Mirrors

Door mirrors Power door mirrors Folding door mirrors Manual folding door mirrors
Heated door mirrors Heated driver and
passenger side door mirrors

Front Side Windows

First-row windows Power first-row windows

Overhead Console

Overhead console Full overhead console Overhead console storage Overhead console
storage

Passenger Visor

Visor passenger mirror Passenger visor mirror

Power Outlets

12V power outlets 2 12V power outlets * **120V AC power outlets** **1 120V AC power
outlet**

Rear Windshield

* **Rear window defroster** **Rear window defroster** * **Rear windshield** **Power rear windshield**

Storage

Number of beverage holders 8 beverage holders Beverage holders Front beverage holders
Beverage holders rear Rear beverage holders Glove box Illuminated locking glove box
Illuminated glove box Illuminated glove box Instrument panel storage Instrument panel
covered bin
Dashboard storage Dashboard storage

Windows Feature

One-touch up window Driver and passenger One-touch down window Driver and passenger
one-touch up windows one-touch down windows

Windows Rear Side

Second-row windows Power second-row
windows

Prices and content availability as shown are subject to change and should be treated as estimates only. Actual base vehicle, package and option pricing may vary from this estimate because of special local pricing, availability or pricing adjustments not reflected in the dealer's computer system. See salesperson for the most current information.

Note: Prices and content availability as shown are subject to change and should be treated as estimates only. Actual base vehicle, package and option pricing may vary from this estimate because of special local pricing, availability or pricing adjustments not reflected in the dealer's computer system. See salesperson for the most current information.



Prepared by: Ed Miller

06/09/2023

Chastang Ford | 6200 N. Loop East Houston Texas | 770261936

2023 F-550 Chassis 4x4 SD Crew Cab 203" WB DRW XL (W5H)

Quote ID: alex24w5h

Selected Equip & Specs (cont'd)

Miscellaneous

Trip computer	Trip computer	PRND in IP	PRND in IP
Upfitter switches	Upfitter switches	Accessory power	Retained accessory power
Over the air updates	Over the air updates		

Comfort

Climate Control

Climate control	Manual climate control	Cabin air filter	Cabin air filter
Rear under seat ducts	Rear under seat climate control ducts		

Headliner

Headliner material	Cloth headliner material	Headliner coverage	Full headliner coverage
--------------------	--------------------------	--------------------	-------------------------

Floor Trim

Floor covering	Full vinyl floor covering	Floor coverage	Full floor coverage
----------------	---------------------------	----------------	---------------------

Second-Row Seat Trim

Rear seat upholstery	Vinyl rear seat upholstery	Rear seatback upholstery	Carpet rear seatback upholstery
----------------------	----------------------------	--------------------------	---------------------------------

Steering Wheel

Steering wheel telescopic steering wheel	Manual telescopic steering wheel	Steering wheel material	Urethane steering wheel
Steering wheel tilt	Manual tilting steering wheel		

Seats and Trim

Seat Capacity

Seating capacity	6
------------------	---

Front Seats

Front seat type	Split-bench front seat	Driver seat direction	Driver seat with 4-way directional controls
Driver seat fore/aft control	Manual driver seat fore/aft control	Passenger seat direction	Front passenger seat with 4-way directional controls
Split front seats	40-20-40 split-bench front seat	Reclining passenger seat	Manual reclining passenger seat
Passenger seat fore/aft control	Manual passenger seat fore/aft control	Front head restraints	Height adjustable front seat head restraints
Front head restraint control	Manual front seat head restraint control	Armrests front center	Front seat center armrest

Prices and content availability as shown are subject to change and should be treated as estimates only. Actual base vehicle, package and option pricing may vary from this estimate because of special local pricing, availability or pricing adjustments not reflected in the dealer's computer system. See salesperson for the most current information.

Note: Prices and content availability as shown are subject to change and should be treated as estimates only. Actual base vehicle, package and option pricing may vary from this estimate because of special local pricing, availability or pricing adjustments not reflected in the dealer's computer system. See salesperson for the most current information.



Prepared by: Ed Miller

06/09/2023

Chastang Ford | 6200 N. Loop East Houston Texas | 770261936

2023 F-550 Chassis 4x4 SD Crew Cab 203" WB DRW XL (W5H)

Quote ID: alex24w5h

Selected Equip & Specs (cont'd)

Armrests front storage Front seat armrest storage

Reclining driver seat Manual reclining driver seat

Rear Seats

Bench seats Split-bench rear seat
Folding second-row seats 60-40 folding rear seats

Rear seats fixed or removable Fixed rear seats
Rear seat direction Front facing rear seat

Rear seat folding position Fold-up rear seat cushion

Rear head restraints Height adjustable rear seat head restraints

Rear head restraint control Manual rear seat head restraint control

Number of rear head restraints 3 rear seat head restraints

Lumbar Seats

Driver lumbar Manual driver seat lumbar

Front Seat Trim

Front seat upholstery Vinyl front seat upholstery

Front seatback upholstery Vinyl front seatback upholstery

Interior Accents

Interior accents Chrome interior accents

Gearshifter Material

Gearshifter material Urethane gear shifter material

Entertainment Features

LCD Displays

Primary touchscreen display Primary touchscreen display
LCD primary display size 8 inch primary LCD display

Number of first-row LCD displays 2 total number of 1st row displays

Radio Features

External memory SYNC 4 external memory control

Seek scan Seek scan

Speakers

Speakers Standard grade speakers

Speakers number 6

Audio Features

Steering mounted audio control Steering wheel mounted audio controls

Speed sensitive volume Speed sensitive volume

Prices and content availability as shown are subject to change and should be treated as estimates only. Actual base vehicle, package and option pricing may vary from this estimate because of special local pricing, availability or pricing adjustments not reflected in the dealer's computer system. See salesperson for the most current information.

Note: Prices and content availability as shown are subject to change and should be treated as estimates only. Actual base vehicle, package and option pricing may vary from this estimate because of special local pricing, availability or pricing adjustments not reflected in the dealer's computer system. See salesperson for the most current information.



Prepared by: Ed Miller

06/09/2023

Chastang Ford | 6200 N. Loop East Houston Texas | 770261936

2023 F-550 Chassis 4x4 SD Crew Cab 203" WB DRW XL (W5H)

Quote ID: alex24w5h

Selected Equip & Specs (cont'd)

Voice activated audio	SYNC 4 voice activated audio controls	Wireless streaming	Wireless audio streaming
-----------------------	---------------------------------------	--------------------	--------------------------

Lighting, Visibility and Instrumentation

Instrumentation

Trip odometer	Trip odometer	Instrumentation display	Digital/analog instrumentation display
Configurable instrumentation gauges	Configurable instrumentation gauges		

Instrumentation Displays

Temperature display	Exterior temperature display	Driver information center	Driver information center
Clock	In-radio display clock	Compass	Compass

Instrumentation Gauges

Tachometer	Tachometer	Transmission temperature gauge	Transmission fluid temperature gauge
* Turbo gauge	Turbo/supercharger boost gauge	Engine/electric motor temperature gauge	Engine/electric motor temperature gauge
Gauge cluster display size (inches)	4.20	Engine hour meter	Engine hour meter
* DEF fluid gauge	Diesel exhaust fluid (def) gauge		

Instrumentation Warnings

Engine temperature warning	Engine temperature warning	Oil pressure warning	Oil pressure warning
Low fuel warning	Low fuel warning	Low brake fluid warning	Low brake fluid warning
Battery charge warning	Battery charge warning	Headlights on reminder	Headlights on reminder
Key in vehicle warning	Key in vehicle warning	Door ajar warning	Door ajar warning
Service interval warning	Service interval indicator	* Low diesel exhaust fluid (DEF) warning	Low diesel exhaust fluid (DEF) warning

Glass

Tinted windows	Light tinted windows
----------------	----------------------

Headlights

Headlights	Halogen headlights	Headlight type	Aero-composite headlights
Auto headlights	Autolamp auto on/off headlight control	Multiple headlights	Multiple enclosed headlights
Delay off headlights	Delay-off headlights	DRL preference setting	DRL preference setting

Prices and content availability as shown are subject to change and should be treated as estimates only. Actual base vehicle, package and option pricing may vary from this estimate because of special local pricing, availability or pricing adjustments not reflected in the dealer's computer system. See salesperson for the most current information.

Note: Prices and content availability as shown are subject to change and should be treated as estimates only. Actual base vehicle, package and option pricing may vary from this estimate because of special local pricing, availability or pricing adjustments not reflected in the dealer's computer system. See salesperson for the most current information.



Prepared by: Ed Miller

06/09/2023

Chastang Ford | 6200 N. Loop East Houston Texas | 770261936

2023 F-550 Chassis 4x4 SD Crew Cab 203" WB DRW XL (W5H)

Quote ID: alex24w5h

Selected Equip & Specs (cont'd)

Front Windshield

Wipers Variable intermittent front windshield wipers

Interior Lighting

Illuminated entry	Illuminated entry	Variable panel light	Variable instrument panel light
Front reading lights	Front reading lights	Rear reading lights	Rear reading lights

Lights

Running lights	Daytime running lights	Interior courtesy lights	Fade interior courtesy lights
* Fog lights	Front fog lights	Clearance lights	Cab clearance lights
Perimeter approach lighting	Remote activated perimeter approach lighting		

Technology and Telematics

Connectivity

Handsfree SYNC 4 handsfree wireless device connectivity	Smart device integration AppLink/Apple CarPlay and Android Auto smart device wireless mirroring
Emergency SOS	SYNC 4 911 Assist emergency SOS system via mobile device

Internet Access

Internet access FordPass Connect 4G mobile hotspot internet access

USB Ports

USB ports 2 USB ports

Safety and Security

Airbags

Front impact airbag driver	Driver front impact airbag	Number of airbags	6 airbags
Front impact airbag passenger	Passenger front impact airbag	Front side impact airbag driver	Seat mounted side impact driver airbag
Front side impact airbag passenger	Seat mounted side impact front passenger airbag	Overhead airbags	Safety Canopy System curtain first and second-row overhead airbags

Prices and content availability as shown are subject to change and should be treated as estimates only. Actual base vehicle, package and option pricing may vary from this estimate because of special local pricing, availability or pricing adjustments not reflected in the dealer's computer system. See salesperson for the most current information.

Note: Prices and content availability as shown are subject to change and should be treated as estimates only. Actual base vehicle, package and option pricing may vary from this estimate because of special local pricing, availability or pricing adjustments not reflected in the dealer's computer system. See salesperson for the most current information.



Prepared by: Ed Miller

06/09/2023

Chastang Ford | 6200 N. Loop East Houston Texas | 770261936

2023 F-550 Chassis 4x4 SD Crew Cab 203" WB DRW XL (W5H)

Quote ID: alex24w5h

Selected Equip & Specs (cont'd)

Seatbelts

Height adjustable seatbelts Front height adjustable seatbelts

Security System

Immobilizer SecuriLock immobilizer Remote panic alarm Remote panic alarm

Active Driving Assistance

Lane departure Lane Departure Warning Forward collision warning Pre-Collision Assist with Automatic Emergency Braking (AEB) forward collision mitigation

Occupant Safety

Child door locks Manual rear child safety door locks

Prices and content availability as shown are subject to change and should be treated as estimates only. Actual base vehicle, package and option pricing may vary from this estimate because of special local pricing, availability or pricing adjustments not reflected in the dealer's computer system. See salesperson for the most current information.

Note: Prices and content availability as shown are subject to change and should be treated as estimates only. Actual base vehicle, package and option pricing may vary from this estimate because of special local pricing, availability or pricing adjustments not reflected in the dealer's computer system. See salesperson for the most current information.



Prepared by: Ed Miller

06/09/2023

Chastang Ford | 6200 N. Loop East Houston Texas | 770261936

2023 F-550 Chassis 4x4 SD Crew Cab 203" WB DRW XL (W5H)

Quote ID: alex24w5h

Warranty

Standard Warranty

Basic Warranty

Basic warranty 36 months/36,000 miles

Powertrain Warranty

Powertrain warranty 60 months/60,000 miles

Corrosion Perforation

Corrosion perforation warranty 60 months/unlimited

Roadside Assistance Warranty

Roadside warranty 60 months/60,000 miles

Additional Warranty

Diesel Engine Warranty

Diesel engine warranty 60 months/100,000 miles

Prices and content availability as shown are subject to change and should be treated as estimates only. Actual base vehicle, package and option pricing may vary from this estimate because of special local pricing, availability or pricing adjustments not reflected in the dealer's computer system. See salesperson for the most current information.

Note: Prices and content availability as shown are subject to change and should be treated as estimates only. Actual base vehicle, package and option pricing may vary from this estimate because of special local pricing, availability or pricing adjustments not reflected in the dealer's computer system. See salesperson for the most current information.